

P400/PX400

Advanced™ Series **PLASTIC** Pumps

EOM

Engineering
Operation &
Maintenance



Advance your process

PRO-FLO[®]
PROGRESSIVE PUMP TECHNOLOGY

PRO-FLO[™]**X**
PROGRESSIVE PUMP TECHNOLOGY



WILDEN[®]

A **DOVER** COMPANY

WIL-11240-E-03
TO REPLACE WIL-11240-E-02

TABLE OF CONTENTS

SECTION 1 CAUTIONS—READ FIRST! 1

SECTION 2 WILDEN PUMP DESIGNATION SYSTEM 2

SECTION 3 HOW IT WORKS—PUMP & AIR DISTRIBUTION SYSTEM...... 3

SECTION 4 DIMENSIONAL DRAWINGS..... 4

SECTION 5 PERFORMANCE

 A. P400 PLASTIC Performance Curves

 Rubber-Fitted..... 5

 TPE-Fitted..... 5

 PTFE-Fitted..... 6

 Full Stroke PTFE-Fitted..... 6

 Suction Lift Curve..... 7

 B. PX400 PLASTIC Performance

 Operating Principal..... 10

 How to Use this EMS Curve..... 11

 Performance Curves

 Rubber-Fitted..... 14

 TPE-Fitted..... 15

 PTFE-Fitted..... 16

 Full Stroke PTFE-Fitted..... 17

 Suction Lift Curve..... 18

SECTION 6 SUGGESTED INSTALLATION, OPERATION & TROUBLESHOOTING..... 19

SECTION 7 DISASSEMBLY/REASSEMBLY

 Pump Disassembly..... 22

 Pro-Flo® Air Valve / Center Section Disassembly..... 25

 Pro-Flo X™ Air Valve / Center Section Disassembly..... 28

 Reassembly Hints & Tips..... 30

SECTION 8 EXPLODED VIEW & PARTS LISTING

 P400 Plastic

 Full Stroke-Fitted..... 32

 Reduced Stroke-Fitted..... 34

 PX400 Plastic

 Full Stroke-Fitted..... 36

 Reduced Stroke-Fitted..... 38

SECTION 9 ELASTOMER OPTIONS..... 40



CAUTIONS—READ FIRST!



CAUTION: Do not apply compressed air to the exhaust port — pump will not function.



CAUTION: Do not over-lubricate air supply — excess lubrication will reduce pump performance. Pump is pre-lubed.



TEMPERATURE LIMITS:

Neoprene	-17.7°C to 93.3°C	0°F to 200°F
Buna-N	-12.2°C to 82.2°C	10°F to 180°F
EPDM	-51.1°C to 137.8°C	-60°F to 280°F
Viton®	-40°C to 176.7°C	-40°F to 350°F
Saniflex™	-28.9°C to 104.4°C	-20°F to 220°F
Polytetrafluoroethylene (PTFE)		
	4.4°C to 104.4°C	40°F to 220°F
Polyurethane	-12.2°C to 65.6°C	10°F to 150°F
Tetra-Flex™ PTFE w/Neoprene Backed		
	4.4°C to 107.2°C	40°F to 225°F
Tetra-Flex™ PTFE w/EPDM Backed		
	-10°C to 137°C	14°F to 280°F

NOTE: Not all materials are available for all models. Refer to Section 2 for material options for your pump.



CAUTION: When choosing pump materials, be sure to check the temperature limits for all wetted components. Example: Viton® has a maximum limit of 176.7°C (350°F) but polypropylene has a maximum limit of only 79°C (175°F).



CAUTION: Maximum temperature limits are based upon mechanical stress only. Certain chemicals will significantly reduce maximum safe operating temperatures. Consult Chemical Resistance Guide (E4) for chemical compatibility and temperature limits.



WARNING: Prevention of static sparking — If static sparking occurs, fire or explosion could result. Pump, valves, and containers must be grounded to a proper grounding point when handling flammable fluids and whenever discharge of static electricity is a hazard.



CAUTION: Do not exceed 8.6 bar (125 psig) air supply pressure.



CAUTION: The process fluid and cleaning fluids must be chemically compatible with all wetted pump components. Consult Chemical Resistance Guide (E4).



CAUTION: Do not exceed 82°C (180°F) air inlet temperature for Pro-Flo X™ models.



CAUTION: Pumps should be thoroughly flushed before installing into process lines. FDA and USDA approved pumps should be cleaned and/or sanitized before being used.



CAUTION: Always wear safety glasses when operating pump. If diaphragm rupture occurs, material being pumped may be forced out air exhaust.



CAUTION: Before any maintenance or repair is attempted, the compressed air line to the pump should be disconnected and all air pressure allowed to bleed from pump. Disconnect all intake, discharge and air lines. Drain the pump by turning it upside down and allowing any fluid to flow into a suitable container.



CAUTION: Blow out air line for 10 to 20 seconds before attaching to pump to make sure all pipeline debris is clear. Use an in-line air filter. A 5µ (micron) air filter is recommended.



NOTE: When installing PFTE diaphragms, it is important to tighten outer pistons simultaneously (turning in opposite directions) to ensure tight fit. (See torque specifications in Section 7.)



NOTE: Cast Iron PFTE-fitted pumps come standard from the factory with expanded PFTE gaskets installed in the diaphragm bead of the liquid chamber. PFTE gaskets cannot be re-used. Consult PS-TG for installation instructions during reassembly.



NOTE: Before starting disassembly, mark a line from each liquid chamber to its corresponding air chamber. This line will assist in proper alignment during reassembly.



CAUTION: Pro-Flo® pumps cannot be used in submersible applications. Pro-Flo X™ is available in both submersible and non-submersible options. Do not use non-submersible Pro-Flo X™ models in submersible applications. Turbo-Flo™ pumps can also be used in submersible applications.



CAUTION: Tighten all hardware prior to installation.

WILDEN PUMP DESIGNATION SYSTEM

**P400/PX400 ADVANCED™
PLASTIC**

**38 mm (1-1/2") Pump
Maximum Flow Rate:
450 lpm (119 gpm)**

LEGEND

PX400 / XXXXX / XXX / XX / XXX / XXXX

MODEL

WETTED PARTS & OUTER PISTON

AIR CHAMBERS

CENTER BLOCK

AIR VALVE

DIAPHRAGMS

VALVE BALLS

O-RINGS

VALVE SEAT

SPECIALTY

CODE

(if applicable)

MATERIAL CODES

MODEL

P400 = PRO-FLO®
PX400 = PRO-FLO™

WETTED PARTS & OUTER PISTON

KK = PVDF / PVDF
PP = POLYPROPYLENE /
POLYPROPYLENE

AIR CHAMBERS

P = POLYPROPYLENE

CENTER BLOCK

L = ACETAL (P400 only)
P = POLYPROPYLENE

AIR VALVE

L = ACETAL (P400 only)
P = POLYPROPYLENE

DIAPHRAGMS

BNS = BUNA-N (Red Dot)
EPS = EPDM (Blue Dot)
FSS = SANIFLEX™
[Hytrel® (Cream)]
NES = NEOPRENE (Green Dot)
PUS = POLYURETHANE (Clear)
TEU = PTFE W/EPDM
BACK-UP (White)
TNU = PTFE W/NEOPRENE
BACK-UP (White)
TSU = PTFE W/SANIFLEX™
BACK-UP (White)
VTS = VITON® (White Dot)
WFS = WIL-FLEX™ [Santoprene®
(Orange Dot)]
TSS = FULL STROKE PTFE
W/SANIFLEX™ BACK-UP
TWS = FULL STROKE PTFE
W/WIL-FLEX™ BACK-UP

VALVE BALL

BN = BUNA-N (Red Dot)
EP = EPDM (Blue Dot)
FS = SANIFLEX™
[Hytrel® (Cream)]
NE = NEOPRENE (Green Dot)
PU = POLYURETHANE (Clear)
TF = PTFE (White)
VT = VITON® (White Dot)
WF = WIL-FLEX™ [Santoprene®
(Orange Dot)]

VALVE SEAT

K = PVDF
P = POLYPROPYLENE

VALVE SEAT O-RING

BN = BUNA-N
TV = PTFE ENCAP. VITON®
WF = WIL-FLEX™ (Santoprene®)

SPECIALTY CODES

- 0100 Wil-Gard II™ 110V
- 0102 Wil-Gard II™, sensor wires ONLY
- 0103 Wil-Gard II™ 220V
- 0502 PFA coated hardware
- 0504 DIN flange
- 0506 DIN flange, PFA coated hardware
- 0604 DIN flange Wil-Gard II™ 220V

Viton® is a registered trademark of DuPont Dow Elastomers.

HOW IT WORKS—PUMP

The Wilden diaphragm pump is an air-operated, positive displacement, self-priming pump. These drawings show flow pattern through the pump upon its initial stroke. It is assumed the pump has no fluid in it prior to its initial stroke.

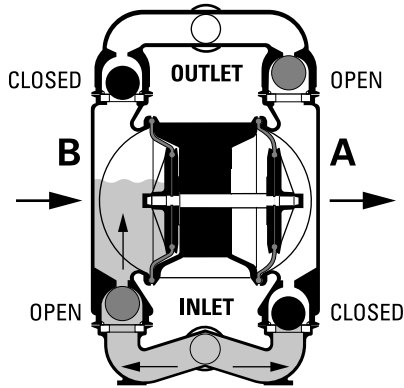

FIGURE 1 The air valve directs pressurized air to the back side of diaphragm A. The compressed air is applied directly to the liquid column separated by elastomeric diaphragms. The diaphragm acts as a separation membrane between the compressed air and liquid, balancing the load and removing mechanical stress from the diaphragm. The compressed air moves the diaphragm away from the center of the pump. The opposite diaphragm is pulled in by the shaft connected to the pressurized diaphragm. Diaphragm B is on its suction stroke; air behind the diaphragm has been forced out to atmosphere through the exhaust port of the pump. The movement of diaphragm B toward the center of the pump creates a vacuum within chamber B. Atmospheric pressure forces fluid into the inlet manifold forcing the inlet valve ball off its seat. Liquid is free to move past the inlet valve ball and fill the liquid chamber (see shaded area).

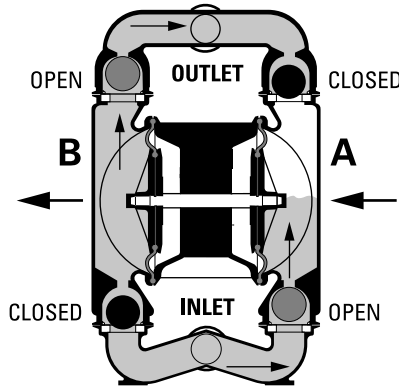

FIGURE 2 When the pressurized diaphragm, diaphragm A, reaches the limit of its discharge stroke, the air valve redirects pressurized air to the back side of diaphragm B. The pressurized air forces diaphragm B away from the center while pulling diaphragm A to the center. Diaphragm B is now on its discharge stroke. Diaphragm B forces the inlet valve ball onto its seat due to the hydraulic forces developed in the liquid chamber and manifold of the pump. These same hydraulic forces lift the discharge valve ball off its seat, forcing fluid to flow through the pump discharge. The movement of diaphragm A toward the center of the pump creates a vacuum within liquid chamber A. Atmospheric pressure forces fluid into the inlet manifold of the pump. The inlet valve ball is forced off its seat allowing the fluid being pumped to fill the liquid chamber.

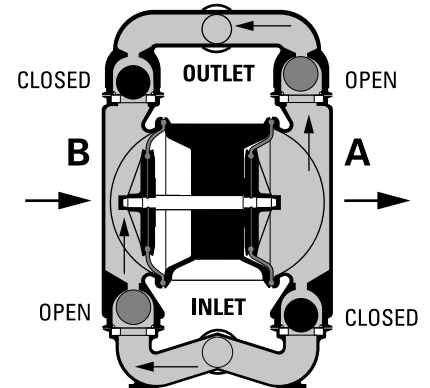
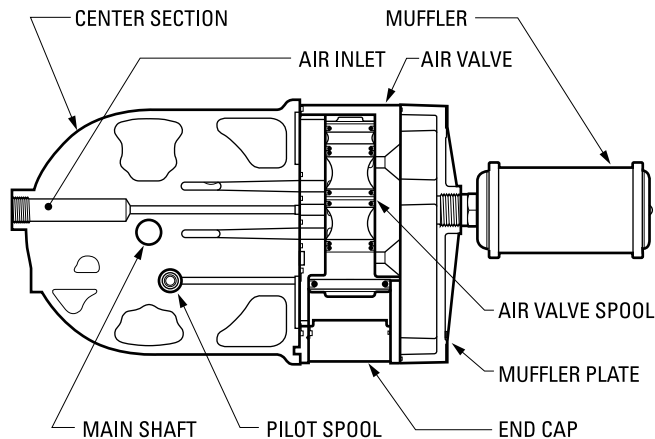

FIGURE 3 At completion of the stroke, the air valve again redirects air to the back side of diaphragm A, which starts diaphragm B on its exhaust stroke. As the pump reaches its original starting point, each diaphragm has gone through one exhaust and one discharge stroke. This constitutes one complete pumping cycle. The pump may take several cycles to completely prime depending on the conditions of the application.

HOW IT WORKS—AIR DISTRIBUTION SYSTEM



The Pro-Flo® patented air distribution system incorporates two moving parts: the air valve spool and the pilot spool. The heart of the system is the air valve spool and air valve. This valve design incorporates an unbalanced spool. The smaller end of the spool is pressurized continuously, while the large end is alternately pressurized then exhausted to move the spool. The spool directs pressurized air to one air chamber while exhausting the other. The air causes the main shaft/diaphragm assembly to shift to one side — discharging liquid on that side and pulling liquid in on the other side. When the shaft reaches the end of its stroke, the inner piston actuates the pilot spool, which pressurizes and exhausts the large end of the air valve spool. The repositioning of the air valve spool routes the air to the other air chamber.

DIMENSIONAL DRAWINGS

P400 Plastic

DIMENSIONS

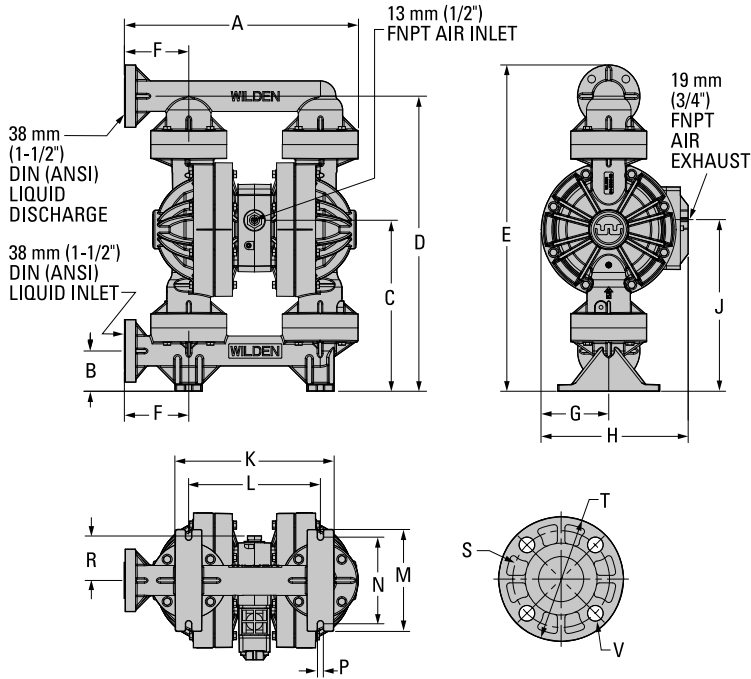

ITEM	METRIC (MM)	STANDARD (inch)
A	478	18.8
B	81	3.2
C	348	13.7
D	605	23.8
E	668	26.3
F	130	5.1
G	137	5.4
H	300	11.8
J	351	13.8
K	325	12.8
L	269	10.6
M	208	8.2
N	175	6.9
P	13	0.5
R	91	3.6
DIN FLANGE		
S	110 DIA.	4.3 DIA.
T	150 DIA.	5.9 DIA.
V	18 DIA.	.7 DIA.
ANSI FLANGE		
S	97 DIA.	3.8 DIA.
T	127 DIA.	5.0 DIA.
V	15 DIA.	.6 DIA.

PX400 Plastic

DIMENSIONS

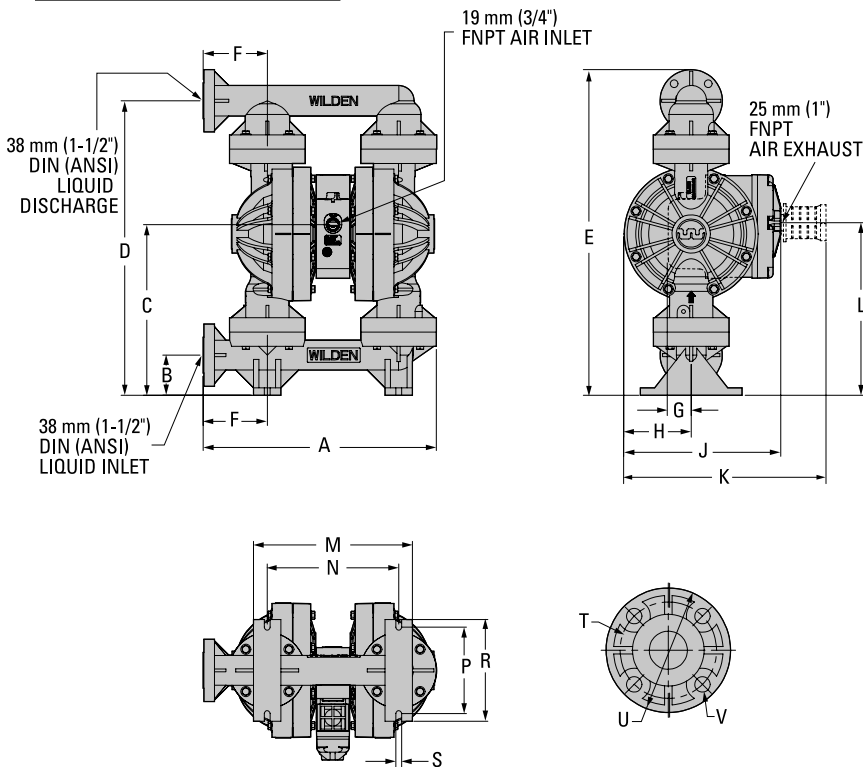

ITEM	METRIC (mm)	STANDARD (inch)
A	478	18.8
B	81	3.2
C	348	13.7
D	605	23.8
E	668	26.3
F	130	5.1
G	48	1.9
H	137	5.4
J	315	12.4
K	411	16.2
L	356	14.0
M	325	12.8
N	269	10.6
P	175	6.9
R	208	8.2
S	13	0.5
DIN FLANGE		
T	110 DIA.	4.3 DIA.
U	150 DIA.	5.9 DIA.
V	18 DIA.	.7 DIA.
ANSI FLANGE		
T	97 DIA.	3.8 DIA.
U	127 DIA.	5.0 DIA.
V	15 DIA.	.6 DIA.

P400 PLASTIC PTFE-FITTED

Height 668 mm (26.3")
 Width 478 mm (18.8")
 Depth 300 mm (11.8")
 Est. Ship Weight... Polypropylene 19 kg (41 lbs)
 PVDF 27 kg (59 lbs)
 Air Inlet 13 mm (1/2")
 Inlet 38 mm (1-1/2")
 Outlet 38 mm (1-1/2")
 Suction Lift 3.3 m Dry (10.8')
 9.7 m Wet (31.8')
 Displacement per
 Stroke..... 0.59 l (0.155 gal.)¹
 Max. Flow Rate 318 lpm (84 gpm)
 Max. Size Solids..... 6.4 mm (1/4")

¹Displacement per stroke was calculated at 4.8 bar (70 psig) air inlet pressure against a 2 bar (30 psig) head pressure.

Example: To pump 178 lpm (47 gpm) against a discharge head pressure of 3.4 bar (50 psig) requires 5.5 bar (80 psig) and 136 Nm³/h (80 scfm) air consumption. (See dot on chart.)

Caution: Do not exceed 8.6 bar (125 psig) air supply pressure.

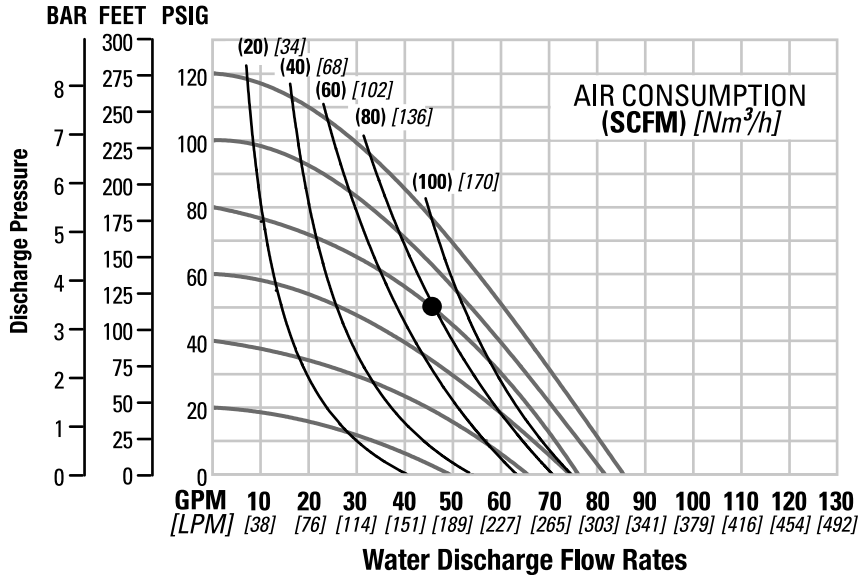

Flow rates indicated on chart were determined by pumping water.

For optimum life and performance, pumps should be specified so that daily operation parameters will fall in the center of the pump performance curve.

P400 PLASTIC FULL STROKE PTFE-FITTED

Height 668 mm (26.3")
 Width 478 mm (18.8")
 Depth 300 mm (11.8")
 Ship Weight . Polypropylene 19 kg (41 lbs.)
 PVDF 27 kg (59 lbs.)
 Air Inlet 13 mm (1/2")
 Inlet 38 mm (1-1/2")
 Outlet 38 mm (1-1/2")
 Suction Lift 5.7 Dry (18.7')
 9.3 m Wet (30.6')
 Disp. Per Stroke 1.1 l (.30 gal.)¹
 Max. Flow Rate 424 lpm (111.9 gpm)
 Max. Size Solids..... 6.4 mm (1/4")

¹Displacement per stroke was calculated at 4.8 bar (70 psig) air inlet pressure against a 2.1 bar (30 psig) head pressure.

Example: To pump 89 GPM against a discharge head of 20 psig requires 80 psig and 93 scfm air consumption.

Caution: Do not exceed 8.6 bar (125 psig) air supply pressure.

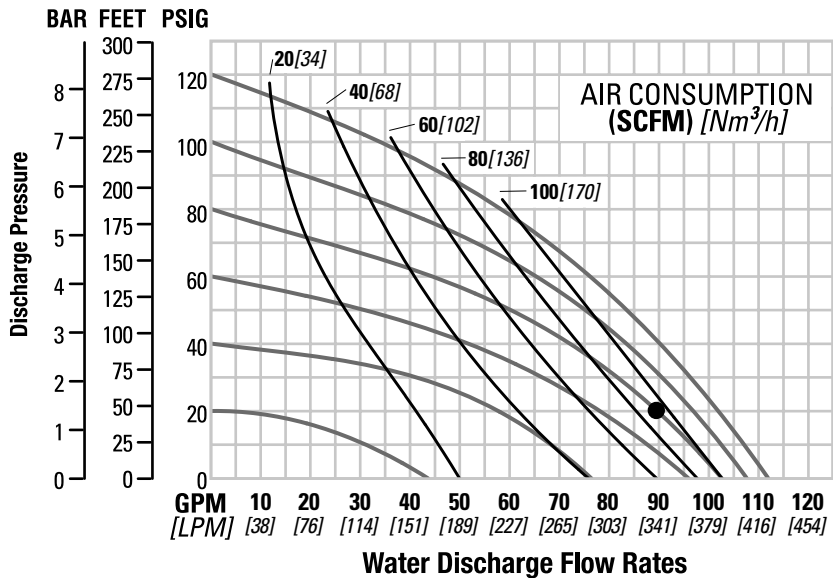

Flow rates indicated on chart were determined by pumping water.

For optimum life and performance, pumps should be specified so that daily operation parameters will fall in the center of the pump performance curve.

P400 PLASTIC SUCTION LIFT CAPABILITY

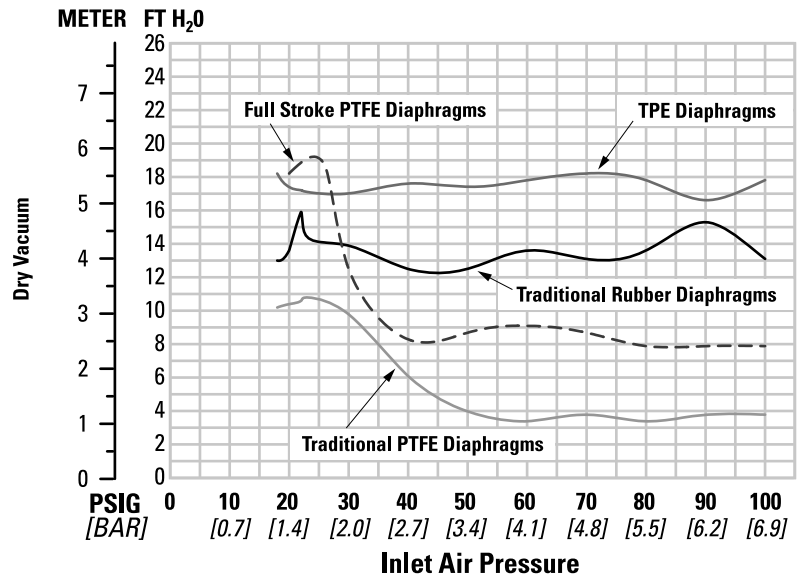

NOTES

PX400

P L A S T I C

WILDEN
A DOVER COMPANY



PX400 PERFORMANCE



Pro-Flo X™ Operating Principal

The Pro-Flo X™ air distribution system with the revolutionary Efficiency Management System (EMS) offers flexibility never before seen in the world of AODD pumps. The patent-pending EMS is simple and easy to use. With the turn of an integrated

control dial, the operator can select the optimal balance of flow and efficiency that best meets the application needs. Pro-Flo X™ provides higher

performance, lower operational costs and flexibility that exceeds previous industry standards.



<p>Turning the dial changes the relationship between air inlet and exhaust porting.</p>	<p>Each dial setting represents an entirely different flow curve</p>	<p>Pro-Flo X™ pumps are shipped from the factory on setting 4, which is the highest flow rate setting possible</p>	<p>Moving the dial from setting 4 causes a decrease in flow and an even greater decrease in air consumption.</p>	<p>When the air consumption decreases more than the flow rate, efficiency is improved and operating costs are reduced.</p>

Example 1

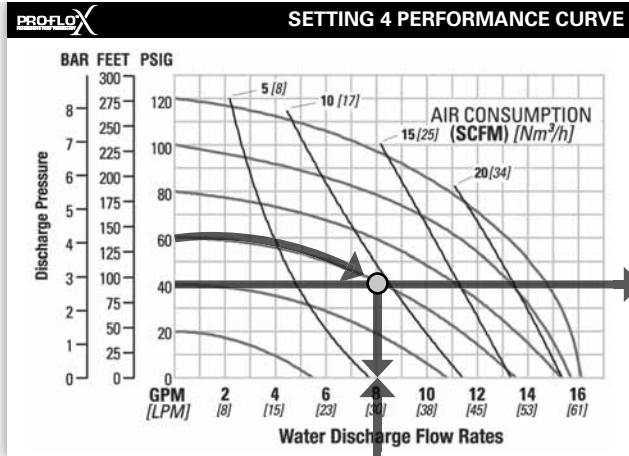

Figure 1

Example data point = **8.2** GPM

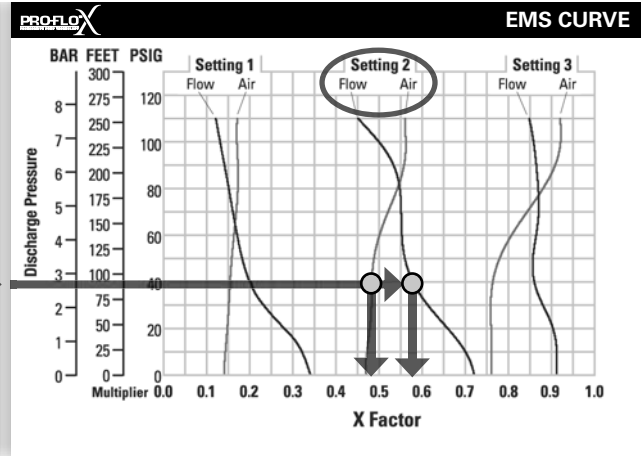

Figure 2

Example data point = **0.58** flow multiplier
0.48 air multiplier

This is an example showing how to determine flow rate and air consumption for your Pro-Flo X™ pump using the Efficiency Management System (EMS) curve and the performance curve. For this example we will be using 4.1 bar (60 psig) inlet air pressure and 2.8 bar (40 psig) discharge pressure and EMS setting 2.

Step 1: Identifying performance at setting 4. Locate the curve that represents the flow rate of the pump with 4.1 bar (60 psig) air inlet pressure. Mark the point where this curve crosses the horizontal line representing 2.8 bar (40 psig) discharge pressure. (Figure 1). After locating your performance point on the flow curve, draw a vertical line downward until reaching the bottom scale on the chart. Identify the flow rate (in this case, 8.2 gpm). Observe location of performance point relative to air consumption curves and approximate air consumption value (in this case, 9.8 scfm).

Step 2: Determining flow and air X Factors. Locate your discharge pressure (40 psig) on the vertical axis of the EMS curve (Figure 2). Follow along the 2.8 bar (40 psig) horizontal line until intersecting both flow and air curves for your desired EMS setting (in this case, setting 2). Mark the points where the EMS curves intersect the horizontal discharge pressure line. After locating your EMS points on the EMS

curve, draw vertical lines downward until reaching the bottom scale on the chart. This identifies the flow X Factor (in this case, 0.58) and air X Factor (in this case, 0.48).

Step 3: Calculating performance for specific EMS setting. Multiply the flow rate (8.2 gpm) obtained in Step 1 by the flow X Factor multiplier (0.58) in Step 2 to determine the flow rate at EMS setting 2. Multiply the air consumption (9.8 scfm) obtained in Step 1 by the air X Factor multiplier (0.48) in Step 2 to determine the air consumption at EMS setting 2 (Figure 3).

8.2 gpm	(flow rate for Setting 4)
.58	(Flow X Factor setting 2)
<hr/>	
4.8 gpm	(Flow rate for setting 2)
9.8 scfm	(air consumption for setting 4)
.48	(Air X Factor setting 2)
<hr/>	
4.7 scfm	(air consumption for setting 2)

Figure 3

The flow rate and air consumption at Setting 2 are found to be 18.2 lpm (4.8 gpm) and 7.9 Nm³/h (4.7 scfm) respectively.

Example 2.1

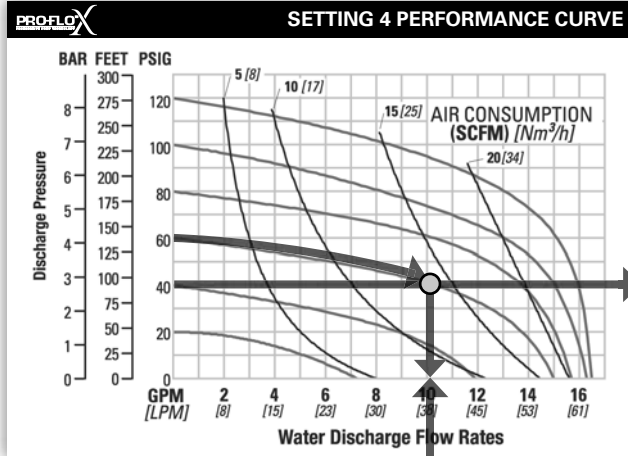

Figure 4

Example data point = **10.2** gpm

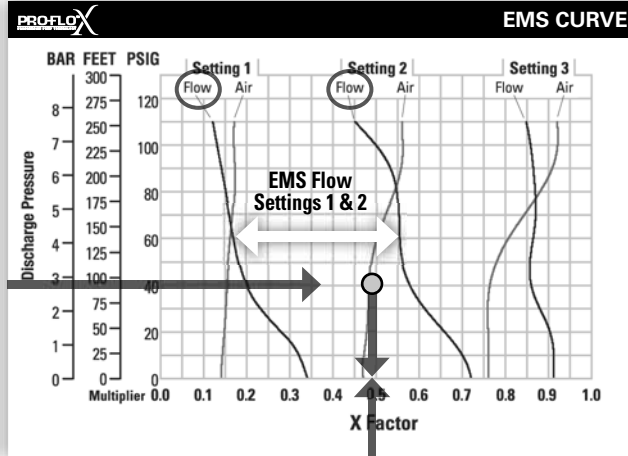

Figure 5

0.49 flow multiplier

This is an example showing how to determine the inlet air pressure and the EMS setting for your Pro-Flo X™ pump to optimize the pump for a specific application. For this example we will be using an application requirement of 18.9 lpm (5 gpm) flow rate against 2.8 bar (40 psig) discharge pressure. This example will illustrate how to calculate the air consumption that could be expected at this operational point.

DETERMINE EMS SETTING

Step 1: Establish inlet air pressure. Higher air pressures will typically allow the pump to run more efficiently, however, available plant air pressure can vary greatly. If an operating pressure of 6.9 bar (100 psig) is chosen when plant air frequently dips to 6.2 bar (90 psig) pump performance will vary. Choose an operating pressure that is within your compressed air system's capabilities. For this example we will choose 4.1 bar (60 psig).

Step 2: Determine performance point at setting 4. For this example an inlet air pressure of 4.1 bar (60 psig) inlet air pressure has been chosen. Locate the curve that represents the performance of the pump with 4.1 bar (60 psig) inlet air pressure. Mark the point where this curve crosses the horizontal line representing 2.8 bar (40 psig) discharge pressure. After locating this point on the flow curve, draw a vertical line downward until reaching the bottom scale on the chart and identify the flow rate.

In our example it is 38.6 lpm (10.2 gpm). This is the setting 4 flow rate. Observe the location of the performance point relative to air consumption curves and approximate air consumption value. In our example setting 4 air consumption is 24 Nm³/h (14 scfm). See figure 4.

Step 3: Determine flow X Factor. Divide the required flow rate 18.9 lpm (5 gpm) by the setting 4 flow rate 38.6 lpm (10.2 gpm) to determine the flow X Factor for the application.

$$5 \text{ gpm} / 10.2 \text{ gpm} = 0.49 \text{ (flow X Factor)}$$

Step 4: Determine EMS setting from the flow X Factor. Plot the point representing the flow X Factor (0.49) and the application discharge pressure 2.8 bar (40 psig) on the EMS curve. This is done by following the horizontal 2.8 bar (40 psig) psig discharge pressure line until it crosses the vertical 0.49 X Factor line. Typically, this point lies between two flow EMS setting curves (in this case, the point lies between the flow curves for EMS setting 1 and 2). Observe the location of the point relative to the two curves it lies between and approximate the EMS setting (figure 5). For more precise results you can mathematically interpolate between the two curves to determine the optimal EMS setting.

For this example the EMS setting is 1.8.

Example 2.2

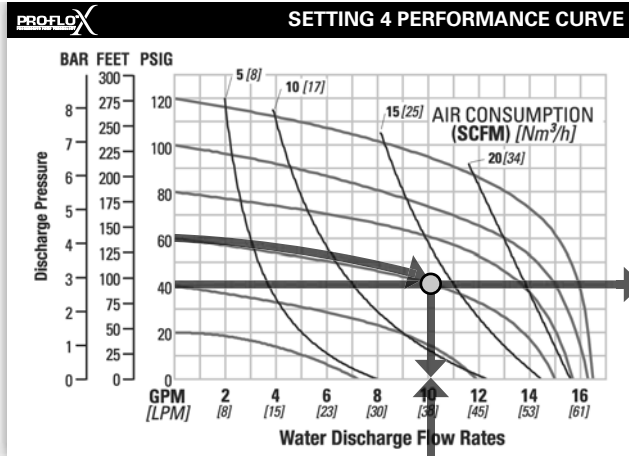

Figure 6

Example data point = **10.2** gpm

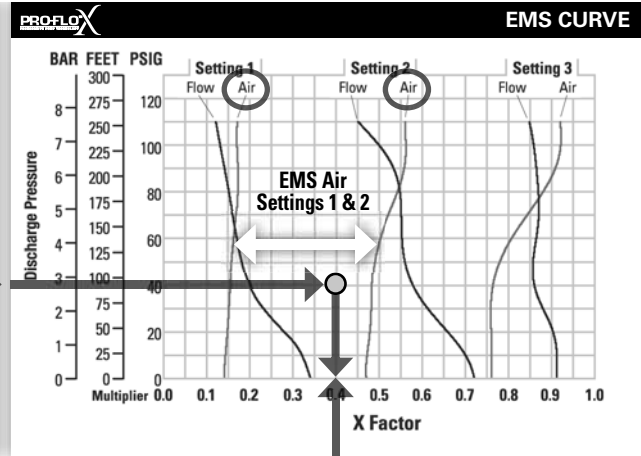

Figure 7

Example data point = **0.40** air multiplier

Determine air consumption at a specific EMS setting.

Step 1: Determine air X Factor. In order to determine the air X Factor, identify the two air EMS setting curves closest to the EMS setting established in example 2.1 (in this case, the point lies between the air curves for EMS setting 1 and 2). The point representing your EMS setting (1.8) must be approximated and plotted on the EMS curve along the horizontal line representing your discharge pressure (in this case, 40 psig). This air point is different than the flow point plotted in example 2.1. After estimating (or interpolating) this point on the curve, draw a vertical line downward until reaching the bottom scale on the chart and identify the air X Factor (figure 7).

For this example the air X Factor is **0.40**

Step 2: Determine air consumption. Multiply your setting 4 air consumption (14 scfm) value by the air X Factor obtained above (0.40) to determine your actual air consumption.

$$14 \text{ scfm} \times 0.40 = 5.6 \text{ SCFM}$$

In summary, for an application requiring 18.9 lpm (5 gpm) against 2.8 bar (40 psig) discharge pressure, the pump inlet air pressure should be set to 4.1 bar (60 psig) and the EMS dial should be set to 1.8. The pump would then consume 9.5 Nm³/h (5.6 scfm) of compressed air.

PX400 PLASTIC RUBBER-FITTED



PERFORMANCE



SETTING 4 PERFORMANCE CURVE

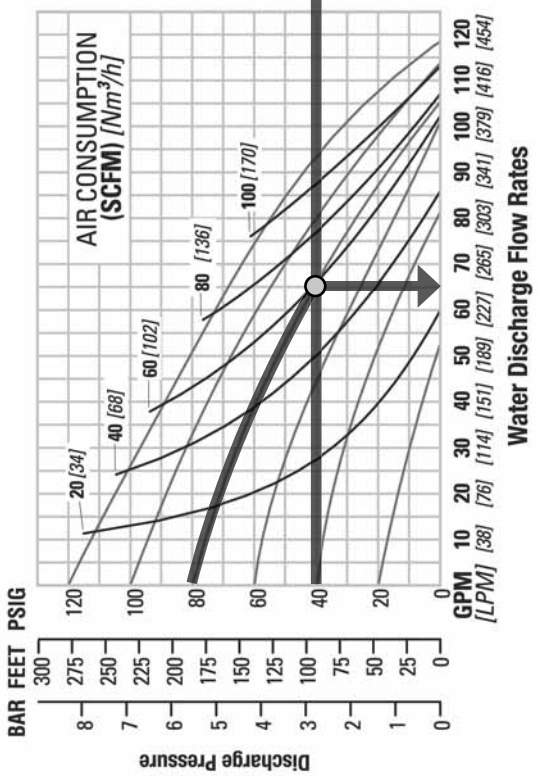

EMS CURVE

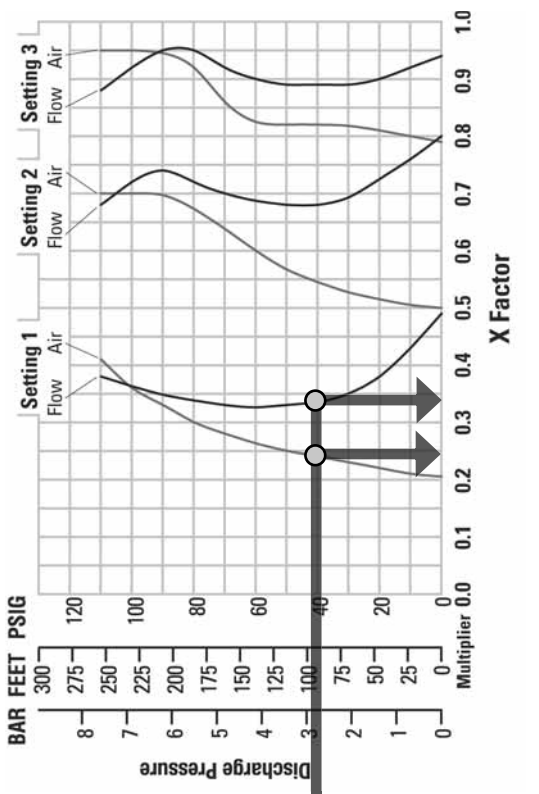

TECHNICAL DATA

Height668 mm (26.3")
Width478 mm (18.8")
Depth315 mm (12.4")
Ship Weight Polypropylene 24 kg (52 lbs.)
Air Inlet 19 mm (3/4")
Inlet 38 mm (1 1/2")
Outlet 38 mm (1 1/2")
Suction Lift5.5 m Dry (18.2')
.....9.3 m Wet (30.6')
Disp. Per Stroke 1.2 l (0.31 gal.)
Max. Flow Rate450 lpm (119 gpm)
Max. Size Solids 6.4 mm (1/4")

¹Displacement per stroke was calculated at 4.8 bar (70 psig) air inlet pressure against a 2.1 bar (30 psig) head pressure.

EXAMPLE

The Efficiency Management System (EMS) can be used to optimize the performance of your Wilden pump for specific applications. The pump is delivered with the EMS adjusted to setting 4, which allows maximum flow.

The EMS curve allows the pump user to determine flow and air consumption at each EMS setting. For any EMS setting and discharge pressure, the "X factor" is used as a multiplier with the original values from the setting 4 performance curve to calculate the actual flow and air consumption values for that specific EMS setting. Note: you can interpolate between the setting curves for operation at intermediate EMS settings.

EXAMPLE

A PX400 polypropylene, rubber-fitted pump operating at EMS setting 4, achieved a flow rate of 250 lpm (66 gpm) using 102 Nm³/h (60 scfm) of air when run at 5.5 bar (80 psig) air inlet pressure and 2.8 bar (40 psig) discharge pressure (See dot on performance curve).

The end user did not require that much flow and wanted to reduce air consumption at his facility. He determined that EMS setting 1 would meet his needs. At 2.8 bar (40 psig) discharge pressure and EMS setting 1, the flow "X factor" is 0.33 and the air "X factor" is 0.24 (see dots on EMS curve).

Multiplying the original setting 4 values by the "X factors" provides the setting 1 flow rate of 82 lpm (22 gpm) and an air consumption of 24 Nm³/h (14 scfm). The flow rate was reduced by 67% while the air consumption was reduced by 76%, thus providing increased efficiency.

For a detailed example for how to set your EMS, see beginning of performance curve section.

Caution: Do not exceed 8.6 bar (125 psig) air supply pressure.

The Efficiency Management System (EMS) can be used to optimize the performance of your Wilden pump for specific applications. The pump is delivered with the EMS adjusted to setting 4, which allows maximum flow.

PX400 PLASTIC TPE-FITTED

SETTING 4 PERFORMANCE CURVE

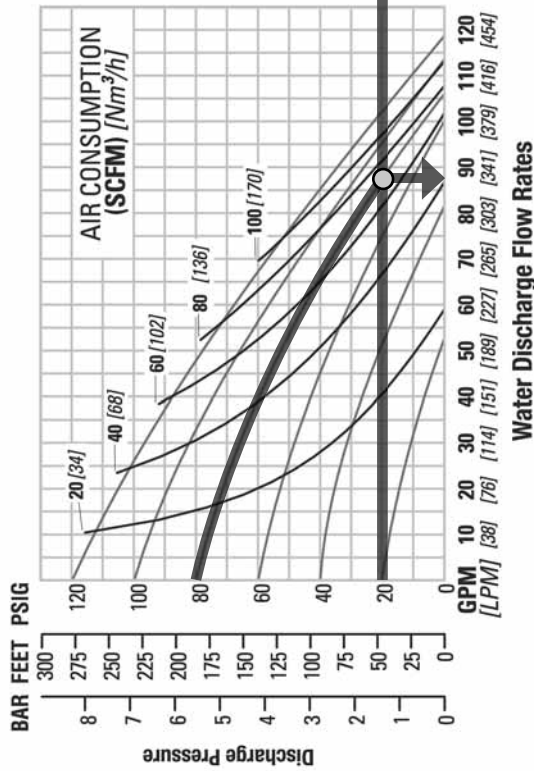

EMS CURVE

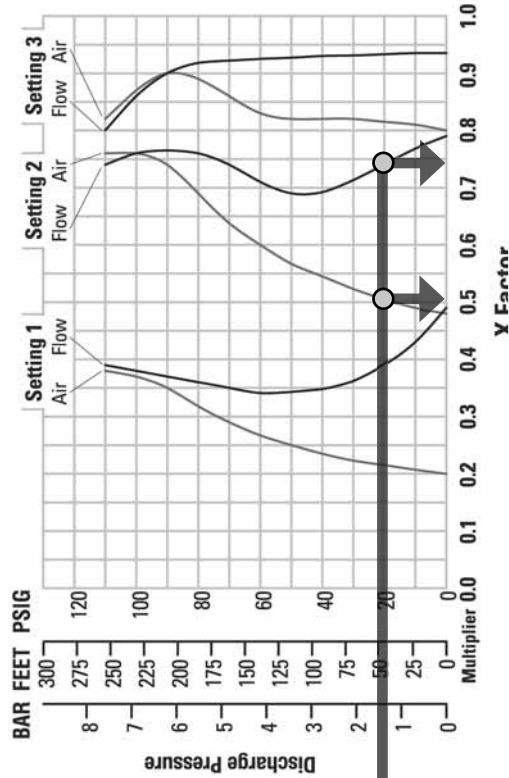

TECHNICAL DATA

Height668 mm (26.3")
Width478 mm (18.8")
Depth315 mm (12.4")
Ship Weight Polypropylene 24 kg (52 lbs.)
Air Inlet 19 mm (3/4")
Inlet 38 mm (1 1/2")
Outlet 38 mm (1 1/2")
Suction Lift 5.5 m Dry (18.2')
..... 9.0 m Wet (29.5')
Disp. Per Stroke 1.1 l (0.30 gal.)
Max. Flow Rate447 lpm (118 gpm)
Max. Size Solids 6.4 mm (1/4")

*Displacement per stroke was calculated at 4.8 bar (70 psig) air inlet pressure against a 2.1 bar (30 psig) head pressure.

The Efficiency Management System (EMS) can be used to optimize the performance of your Wilden pump for specific applications. The pump is delivered with the EMS adjusted to setting 4, which allows maximum flow.

The EMS curve allows the pump user to determine flow and air consumption at each EMS setting. For any EMS setting and discharge pressure, the "X factor" is used as a multiplier with the original values from the setting 4 performance curve to calculate the actual flow and air consumption values for that specific EMS setting. Note: you can interpolate between the setting curves for operation at intermediate EMS settings.

The Efficiency Management System (EMS) can be used to optimize the performance of your Wilden pump for specific applications. The pump is delivered with the EMS adjusted to setting 4, which allows maximum flow.

EXAMPLE

A PX400 polypropylene, TPE-fitted pump operating at EMS setting 4, achieved a flow rate of 329 lpm (87 gpm) using 121 Nm³/h (71 scfm) of air when run at 5.5 bar (80 psig) air inlet pressure and 1.4 bar (20 psig) discharge pressure (See dot on performance curve).

The end user did not require that much flow and wanted to reduce air consumption at his facility. He determined that EMS setting 2 would meet his needs. At 1.4 bar (20 psig) discharge pressure and EMS setting 2, the flow "X factor" is 0.74 and the air "X factor" is 0.51 (see dots on EMS curve).

Multiplying the original setting 4 values by the "X factors" provides the setting 2 flow rate of 244 lpm (64 gpm) and an air consumption of 62 Nm³/h (36 scfm). The flow rate was reduced by 26% while the air consumption was reduced by 49%, thus providing increased efficiency.

For a detailed example for how to set your EMS, see beginning of performance curve section.

Caution: Do not exceed 8.6 bar (125 psig) air supply pressure.

PX400 PLASTIC PTFE-FITTED



PERFORMANCE



SETTING 4 PERFORMANCE CURVE

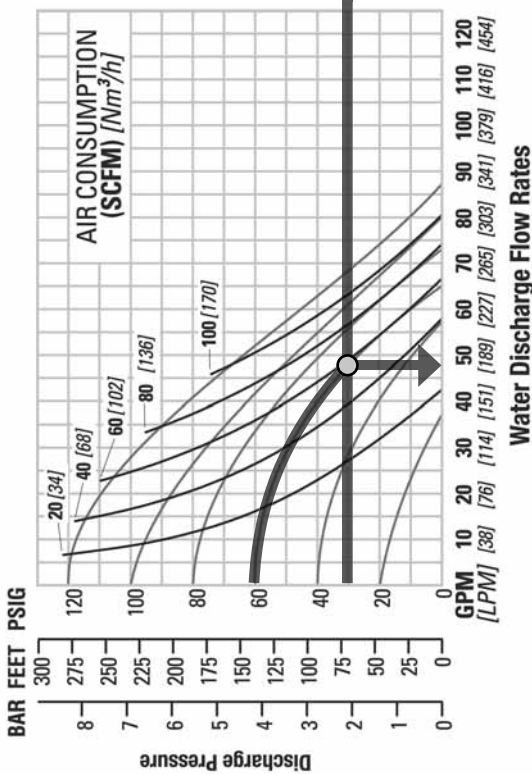

EMS CURVE

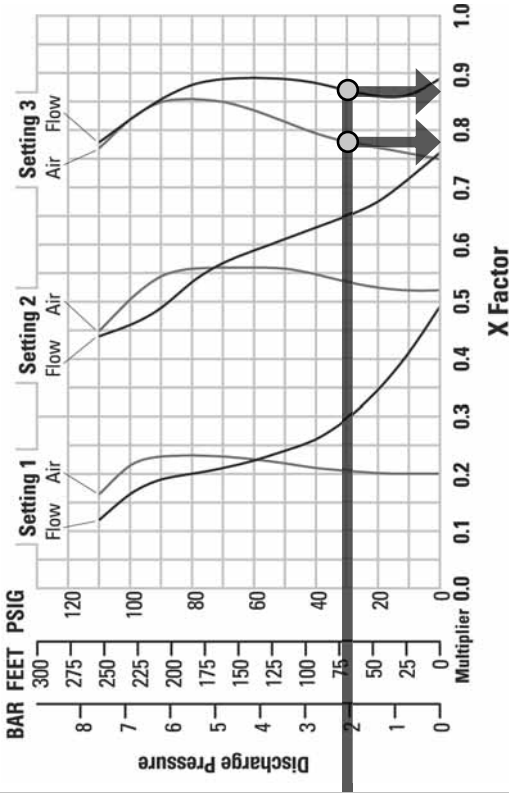

TECHNICAL DATA

Height668 mm (26.3")
Width478 mm (18.8")
Depth315 mm (12.4")
Ship Weight Polypropylene 24 kg (52 lbs.)
Air Inlet 19 mm (3/4")
Inlet 38 mm (1 1/2")
Outlet 38 mm (1 1/2")
Suction Lift 3.6 m Dry (11.9')
 7.6 m Wet (25.0')
Disp. Per Stroke 0.6 l (0.15 gal.)
Max. Flow Rate 329 lpm (87 gpm)
Max. Size Solids 6.4 mm (1/4")

¹Displacement per stroke was calculated at 4.8 bar (70 psig) air inlet pressure against a 2.1 bar (30 psig) head pressure.

The Efficiency Management System (EMS) can be used to optimize the performance of your Wilden pump for specific applications. The pump is delivered with the EMS adjusted to setting 4, which allows maximum flow.

The EMS curve allows the pump user to determine flow and air consumption at each EMS setting. For any EMS setting and discharge pressure, the "X factor" is used as a multiplier with the original values from the setting 4 performance curve to calculate the actual flow and air consumption values for that specific EMS setting. Note: you can interpolate between the setting curves for operation at intermediate EMS settings.

The Efficiency Management System (EMS) can be used to optimize the performance of your Wilden pump for specific applications. The pump is delivered with the EMS adjusted to setting 4, which allows maximum flow.

EXAMPLE

A PX400 polypropylene, PTFE-fitted pump operating at EMS setting 4, achieved a flow rate of 182 lpm (48 gpm) using 95 Nm³/h (56 scfm) of air when run at 4.1 bar (60 psig) air inlet pressure and 2.1 bar (30 psig) discharge pressure (See dot on performance curve).

The end user did not require that much flow and wanted to reduce air consumption at his facility. He determined that EMS setting 3 would meet his needs. At 2.1 bar (30 psig) discharge pressure and EMS setting 3, the flow "X factor" is 0.87 and the air "X factor" is 0.78 (see dots on EMS curve).

Multiplying the original setting 4 values by the "X factors" provides the setting 3 flow rate of 158 lpm (42 gpm) and an air consumption of 74 Nm³/h (44 scfm). The flow rate was reduced by 13% while the air consumption was reduced by 22%, thus providing increased efficiency.

For a detailed example for how to set your EMS, see beginning of performance curve section.

Caution: Do not exceed 8.6 bar (125 psig) air supply pressure.

PX400 PLASTIC FULL STROKE PTFE-FITTED

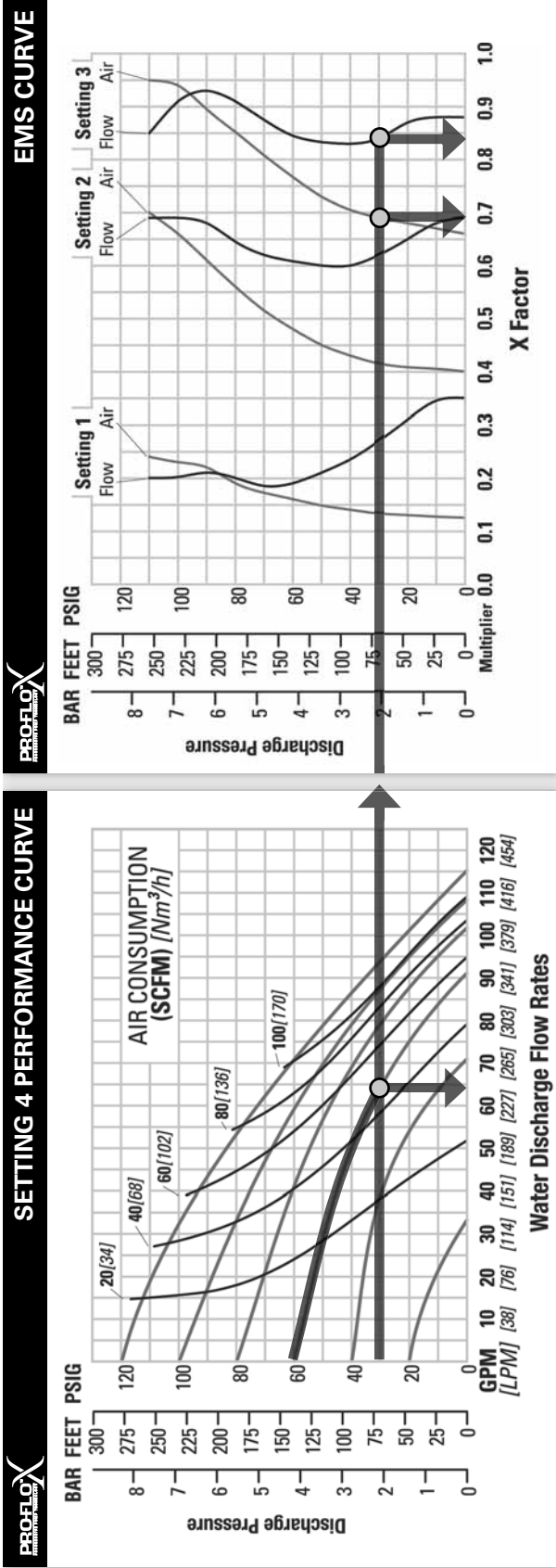

TECHNICAL DATA

Height 668 mm (26.3")
Width 478 mm (18.8")
Depth 315 mm (12.4")
Ship Weight Polypropylene 24 kg (52 lbs.)
Air Inlet 19 mm (3/4")
Inlet 38 mm (1-1/2")
Outlet 38 mm (1-1/2")
Suction Lift 5.6 m Dry (18.4') 9.0 m Wet (29.5')
Disp. Per Stroke 1.1 l (.29 gal.) ¹
Max. Flow Rate 436 lpm (115.2 gpm)
Max. Size Solids 6.4 mm (1/4")

¹Displacement per stroke was calculated at 4.8 bar (70 psig) air inlet pressure against a 2.1 bar (30 psig) head pressure.

The Efficiency Management System (EMS) can be used to optimize the performance of your Wilden pump for specific applications. The pump is delivered with the EMS adjusted to setting 4, which allows maximum flow.

The EMS curve allows the pump user to determine flow and air consumption at each EMS setting. For any EMS setting and discharge pressure, the "X factor" is used as a multiplier with the original values from the setting 4 performance curve to calculate the actual flow and air consumption values for that specific EMS setting. Note: you can interpolate between the setting curves for operation at intermediate EMS settings.

The Efficiency Management System (EMS) can be used to optimize the performance of your Wilden pump for specific applications. The pump is delivered with the EMS adjusted to setting 4, which allows maximum flow.

EXAMPLE

A PX400 Polypropylene, Full Flow PTFE fitted pump operating at EMS setting 4, achieved a flow rate of 242 lpm (64 gpm) using 80 Nm³/h (47 scfm) of air when run at 4.1 bar (60 psig) air inlet pressure and 2.1 bar (30 psig) discharge pressure (See dot on performance curve).

The end user did not require that much flow and wanted to reduce air consumption at his facility. He determined that EMS setting 3 would meet his needs. At 2.1 bar (30 psig) discharge pressure and EMS setting 3, the flow "X factor" is 0.84 and the air "X factor" is 0.69 (see dots on EMS curve).

Multiplying the original setting 4 values by the "X factors" provides the setting 3 flow rate of 204 lpm (54 gpm) and an air consumption of 55 Nm³/h (32 scfm). The flow rate was reduced by 16% while the air consumption was reduced by 31%, thus providing increased efficiency.

For a detailed example for how to set your EMS, see beginning of performance curve section.

Caution: Do not exceed 8.6 bar (125 psig) air supply pressure.

SUCTION LIFT CURVES

**PX400 PLASTIC
SUCTION LIFT
CAPABILITY**

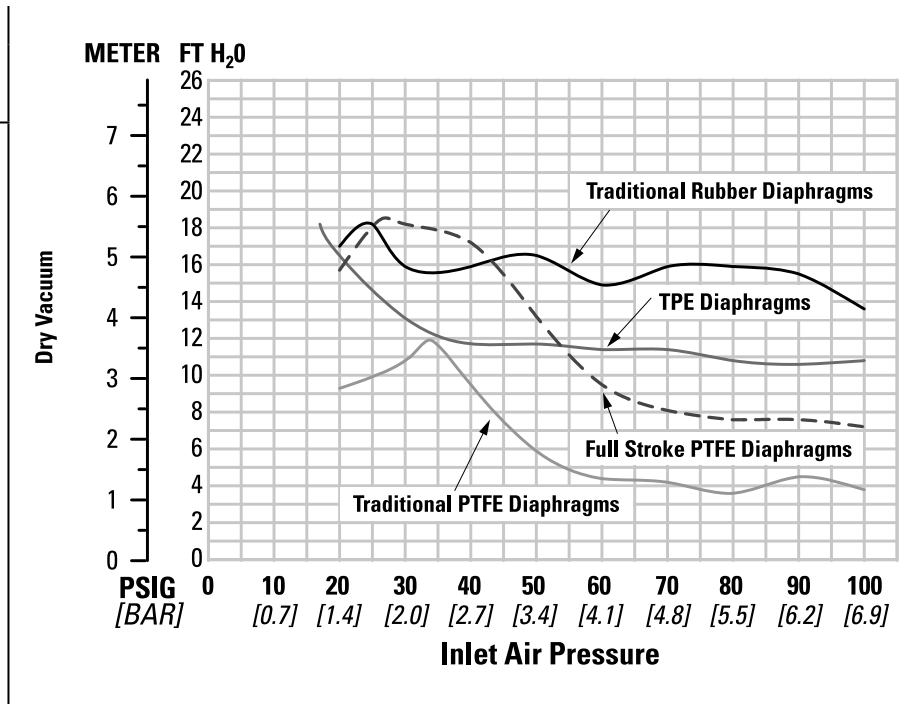

SUGGESTED INSTALLATION

Wilden pumps are designed to meet the performance requirements of even the most demanding pumping applications. They have been designed and manufactured to the highest standards and are available in a variety of liquid path materials to meet your chemical resistance needs. Refer to the performance section of this manual for an in-depth analysis of the performance characteristics of your pump. Wilden offers the widest variety of elastomer options in the industry to satisfy temperature, chemical compatibility, abrasion resistance and flex concerns.

The suction pipe size should be at least the equivalent or larger than the diameter size of the suction inlet on your Wilden pump. The suction hose must be non-collapsible, reinforced type as these pumps are capable of pulling a high vacuum. Discharge piping should also be the equivalent or larger than the diameter of the pump discharge which will help reduce friction losses. It is critical that all fittings and connections are airtight or a reduction or loss of pump suction capability will result.

INSTALLATION: Months of careful planning, study, and selection efforts can result in unsatisfactory pump performance if installation details are left to chance.

Premature failure and long term dissatisfaction can be avoided if reasonable care is exercised throughout the installation process.

LOCATION: Noise, safety, and other logistical factors usually dictate where equipment will be situated on the production floor. Multiple installations with conflicting requirements can result in congestion of utility areas, leaving few choices for additional pumps.

Within the framework of these and other existing conditions, every pump should be located in such a way that six key factors are balanced against each other to maximum advantage.

ACCESS: First of all, the location should be accessible. If it's easy to reach the pump, maintenance personnel will have an easier time carrying out routine inspections and adjustments. Should major repairs become necessary, ease of access can play a key role in speeding the repair process and reducing total downtime.

AIR SUPPLY: Every pump location should have an air line large enough to supply the volume of air necessary to achieve the desired pumping rate. Use air pressure up to a maximum of 8.6 bar (125 psig) depending on pumping requirements.

For best results, the pumps should use a 5µ (micron) air filter, needle valve and regulator. The use of an air filter before the pump will ensure that the majority of any pipeline contaminants will be eliminated.

SOLENOID OPERATION: When operation is controlled by a solenoid valve in the air line, three-way valves should be used. This valve allows trapped air between the valve and the pump to bleed off which improves pump performance. Pumping volume can be estimated by counting the number of strokes per minute and then multiplying the figure by the displacement per stroke.

MUFFLER: Sound levels are reduced below OSHA specifications using the standard Wilden muffler. Other

mufflers can be used to further reduce sound levels, but they usually reduce pump performance.

ELEVATION: Selecting a site that is well within the pump's dynamic lift capability will assure that loss-of-prime issues will be eliminated. In addition, pump efficiency can be adversely affected if proper attention is not given to site location.

PIPING: Final determination of the pump site should not be made until the piping challenges of each possible location have been evaluated. The impact of current and future installations should be considered ahead of time to make sure that inadvertent restrictions are not created for any remaining sites.

The best choice possible will be a site involving the shortest and straightest hook-up of suction and discharge piping. Unnecessary elbows, bends, and fittings should be avoided. Pipe sizes should be selected to keep friction losses within practical limits. All piping should be supported independently of the pump. In addition, the piping should be aligned to avoid placing stress on the pump fittings.

Flexible hose can be installed to aid in absorbing the forces created by the natural reciprocating action of the pump. If the pump is to be bolted down to a solid location, a mounting pad placed between the pump and the foundation will assist in minimizing pump vibration. Flexible connections between the pump and rigid piping will also assist in minimizing pump vibration. If quick-closing valves are installed at any point in the discharge system, or if pulsation within a system becomes a problem, a surge suppressor (SD Equalizer®) should be installed to protect the pump, piping and gauges from surges and water hammer.

If the pump is to be used in a self-priming application, make sure that all connections are airtight and that the suction lift is within the model's ability. Note: Materials of construction and elastomer material have an effect on suction lift parameters. Please refer to the performance section for specifics.

When pumps are installed in applications involving flooded suction or suction head pressures, a gate valve should be installed in the suction line to permit closing of the line for pump service.

Pumps in service with a positive suction head are most efficient when inlet pressure is limited to 0.5–0.7 bar (7–10 psig). Premature diaphragm failure may occur if positive suction is 0.7 bar (10 psig) and higher.

SUBMERSIBLE APPLICATIONS: Pro-Flo X™ pumps can be used for submersible applications, when using the Pro-Flo X™ single point exhaust option. Turbo-Flo™ pumps can also be used for submersible applications.

NOTE: Pro-Flo® and Accu-Flo™ pumps are not submersible.

ALL WILDEN PUMPS ARE CAPABLE OF PASSING SOLIDS. A STRAINER SHOULD BE USED ON THE PUMP INTAKE TO ENSURE THAT THE PUMP'S RATED SOLIDS CAPACITY IS NOT EXCEEDED.

CAUTION: DO NOT EXCEED 8.6 BAR (125 PSIG) AIR SUPPLY PRESSURE.

SUGGESTED INSTALLATION

This illustration is a generic representation of an air-operated double-diaphragm pump.

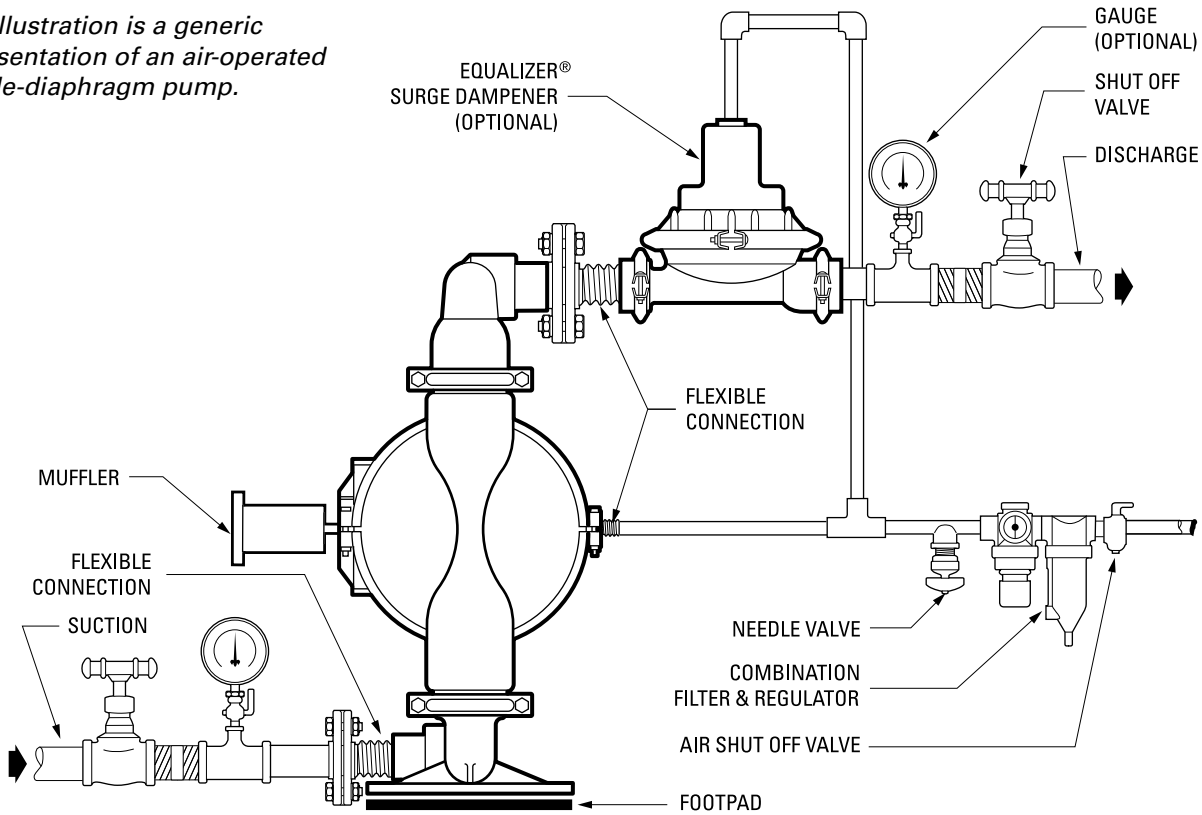

NOTE: In the event of a power failure, the shut off valve should be closed, if the restarting of the pump is not desirable once power is regained.

AIR OPERATED PUMPS: To stop the pump from operating in an emergency situation, simply close the

shut off valve (user supplied) installed in the air supply line. A properly functioning valve will stop the air supply to the pump, therefore stopping output. This shut off valve should be located far enough away from the pumping equipment such that it can be reached safely in an emergency situation.

OPERATION: The P400 and PX400 are pre-lubricated, and do not require in-line lubrication. Additional lubrication will not damage the pump, however if the pump is heavily lubricated by an external source, the pump's internal lubrication may be washed away. If the pump is then moved to a non-lubricated location, it may need to be disassembled and re-lubricated as described in the ASSEMBLY/DISASSEMBLY INSTRUCTIONS.

Pump discharge rate can be controlled by limiting the volume and/or pressure of the air supply to the pump. An air regulator is used to regulate air pressure. A needle valve is used to regulate volume. Pump discharge rate can also be controlled by throttling the pump discharge by partially closing a valve in the discharge line of the pump. This action increases friction loss which reduces flow rate. (See Section 5.) This is useful when the need exists to control the pump from a remote location. When the pump discharge pressure equals or exceeds the air supply pressure, the pump will stop; no bypass or pressure relief valve is needed, and pump damage will not occur. The pump has reached a "deadhead" situation and can

be restarted by reducing the fluid discharge pressure or increasing the air inlet pressure. The Wilden P400 and PX400 pumps run solely on compressed air and do not generate heat, therefore your process fluid temperature will not be affected.

MAINTENANCE AND INSPECTIONS: Since each application is unique, maintenance schedules may be different for every pump. Frequency of use, line pressure, viscosity and abrasiveness of process fluid all affect the parts life of a Wilden pump. Periodic inspections have been found to offer the best means for preventing unscheduled pump downtime. Personnel familiar with the pump's construction and service should be informed of any abnormalities that are detected during operation.

RECORDS: When service is required, a record should be made of all necessary repairs and replacements. Over a period of time, such records can become a valuable tool for predicting and preventing future maintenance problems and unscheduled downtime. In addition, accurate records make it possible to identify pumps that are poorly suited to their applications.

TROUBLESHOOTING

Pump will not run or runs slowly.

1. Ensure that the air inlet pressure is at least 0.4 bar (5 psig) above startup pressure and that the differential pressure (the difference between air inlet and liquid discharge pressures) is not less than 0.7 bar (10 psig).
2. Check air inlet filter for debris (see recommended installation).
3. Check for extreme air leakage (blow by) which would indicate worn seals/bores in the air valve, pilot spool, main shaft.
4. Disassemble pump and check for obstructions in the air passageways or objects which would obstruct the movement of internal parts.
5. Check for sticking ball check valves. If material being pumped is not compatible with pump elastomers, swelling may occur. Replace ball check valves and seals with proper elastomers. Also, as the check valve balls wear out, they become smaller and can become stuck in the seats. In this case, replace balls and seats.
6. Check for broken inner piston which will cause the air valve spool to be unable to shift.
7. Remove plug from pilot spool exhaust.

Pump runs but little or no product flows.

1. Check for pump cavitation; slow pump speed down to allow thick material to flow into liquid chambers.

2. Verify that vacuum required to lift liquid is not greater than the vapor pressure of the material being pumped (cavitation).
3. Check for sticking ball check valves. If material being pumped is not compatible with pump elastomers, swelling may occur. Replace ball check valves and seats with proper elastomers. Also, as the check valve balls wear out, they become smaller and can become stuck in the seats. In this case, replace balls and seats.

Pump air valve freezes.

1. Check for excessive moisture in compressed air. Either install a dryer or hot air generator for compressed air. Alternatively, a coalescing filter may be used to remove the water from the compressed air in some applications.

Air bubbles in pump discharge.

1. Check for ruptured diaphragm.
2. Check tightness of outer pistons (refer to Section 7).
3. Check tightness of fasteners and integrity of o-rings and seals, especially at intake manifold.
4. Ensure pipe connections are airtight.

Product comes out air exhaust.

1. Check for diaphragm rupture.
2. Check tightness of outer pistons to shaft.

PUMP DISASSEMBLY

Tools Required:

- 9/16" Wrench
- Adjustable Wrench
- Vise equipped with soft jaws (such as plywood, plastic or other suitable material)

CAUTION: Before any maintenance or repair is attempted, the compressed air line to the pump should be disconnected and all air pressure allowed to bleed from the pump. Disconnect all intake, discharge, and air lines. Drain the pump by turning it upside down and allowing any fluid to flow into a suitable container. Be aware of any hazardous effects of contact with your process fluid.

NOTE: The model photographed for these instructions incorporates PTFE diaphragms, balls, and seats. Models with Rubber diaphragms, balls and seats are the same except where noted.

**Step 1**

Please note alignment marks on liquid chambers. Use to properly align center section with liquid chamber.

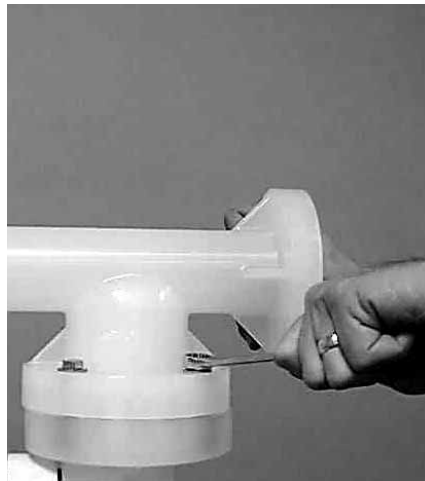
**Step 2**

Using a 9/16" wrench, loosen the discharge manifold from the liquid chambers.

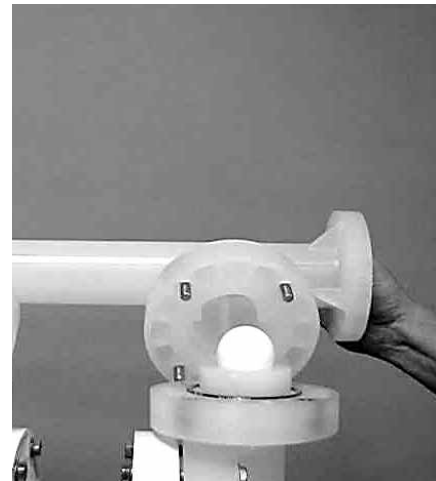
**Step 3**

Remove the discharge manifold to expose the valve balls, valve seats and valve seat o-rings.



Step 4

Inspect valve balls, valve seats, and valve seat o-rings for nicks, gouges, chemical attack or abrasive wear.

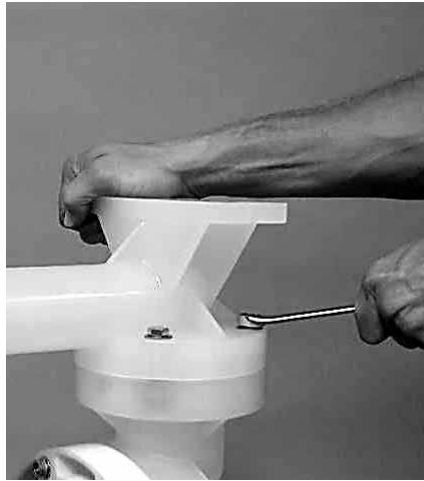

Step 5

Using a 9/16" wrench, loosen the inlet manifold from the liquid chambers.

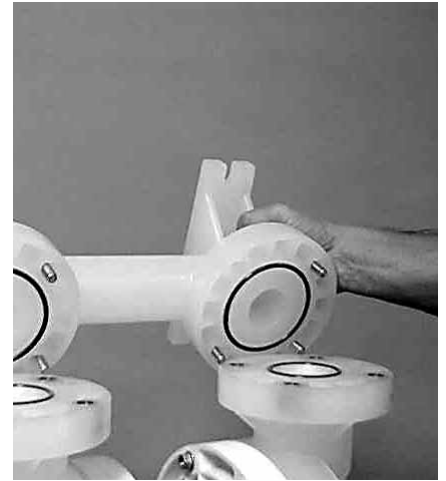

Step 6

Remove the inlet manifold, valve balls, valve seats and valve seat o-rings and inspect for nicks, gouges, chemical attack or abrasive wear.



Step 7

Using a 9/16" wrench, remove the liquid chamber fasteners that secure the liquid chamber to the center section.



Step 8

Remove the liquid chamber to expose the diaphragm and outer piston.



Step 9

Using two adjustable wrenches, or rotating both diaphragms by hand (counterclockwise), remove the diaphragm assembly from the center section assembly.

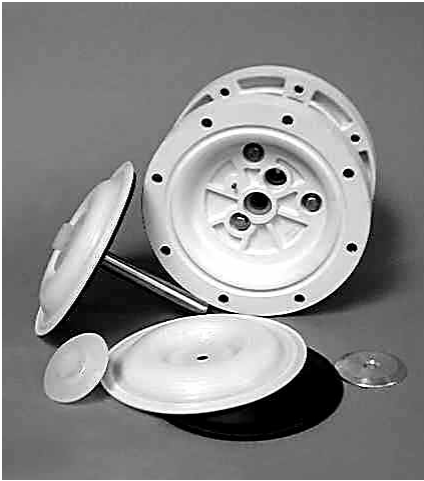

Step 10

Due to varying torque values, one of the following two situations may occur:

- 1) The outer piston, diaphragm and inner piston remain attached to the shaft and the entire assembly can be removed from the center section.
- 2) The outer piston, diaphragm and inner piston separate from the shaft, which remains connected to the opposite side diaphragm assembly.



Step 11

Remove diaphragm assembly from shaft, secure shaft with soft jaws (a vise fitted with plywood, plastic or other suitable material) to ensure shaft is not nicked, scratched or gouged. Using an adjustable wrench or rotating counterclockwise by hand, remove diaphragm assembly from shaft.

PRO-FLO[®] AIR DISTRIBUTION SYSTEM (ADS) DISASSEMBLY

Tools Required:

- 3/16" Wrench
- O-ring Pick

CAUTION: Before any maintenance or repair is attempted, the compressed air line to the pump should be disconnected and all air pressure allowed to bleed from the pump. Disconnect all intake, discharge, and air lines. Drain the pump by turning it upside down and allowing any fluid to flow into a suitable container. Be aware of hazardous effects of contact with your process fluid.



Step 1

Using a 3/16" hex head wrench, loosen air valve bolts.

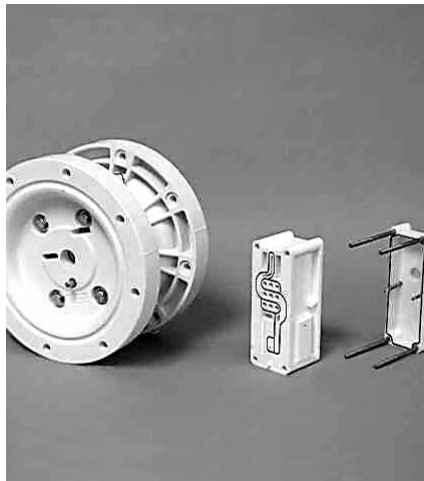

Step 2

Remove muffer plate and air valve bolts from air valve assembly, exposing muffer gasket for inspection. Replace if necessary.



Step 3

Lift away air valve assembly and remove air valve gasket for inspection. Replace if necessary.

PRO-FLO[®] AIR DISTRIBUTION SYSTEM (ADS) DISASSEMBLY



Step 4

Remove air valve end cap to expose air valve spool by simply lifting up on end cap once air valve bolts are removed. Note: Pro-Flo V™ air valve incorporates an end cap at both ends of the air valve.



Step 5

Remove the air valve spool from the air valve body by threading one air valve bolt into the end of the air valve spool and gently sliding the spool out of the air valve body. Inspect seals for signs of wear and replace entire assembly if necessary. Use caution when handling air valve spool to prevent damaging seals. Note: Seals should not be removed from assembly. Seals are not sold separately.



Step 6

Remove pilot sleeve from center section. To do so, the air chambers must be removed from the center block which will expose the pilot spool sleeve.

PRO-FLO[®] AIR DISTRIBUTION SYSTEM (ADS) DISASSEMBLY

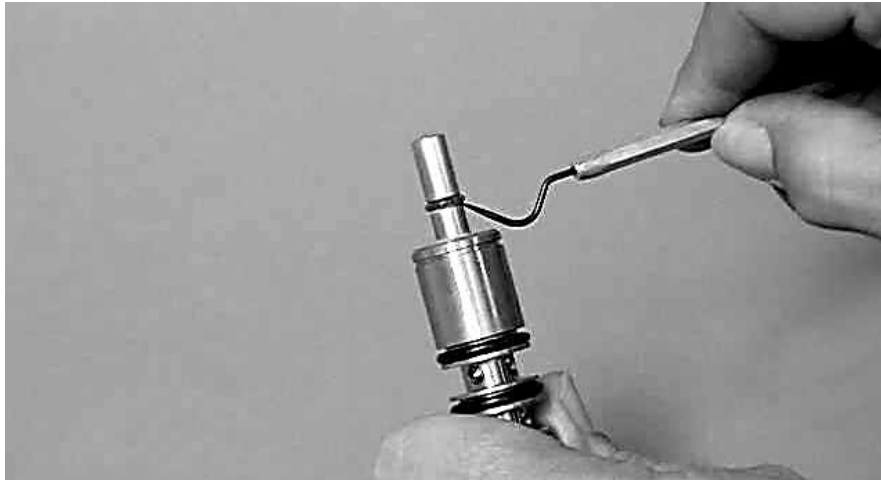

Step 7

Using an o-ring pick, gently remove the o-ring from the opposite side of the "notched end" on one side of the pilot spool. Gently remove the pilot spool from pilot spool sleeve and inspect for nicks, gouges and wear. Replace pilot sleeve or outer sleeve o-rings if necessary. During re-assembly, never insert the pilot spool into the sleeve with the "notched end" first, this end incorporates the urethane o-ring and will be damaged as it slides over the ports cut in the sleeve. Note: Seals should not be removed from pilot spool. Seals are not sold separately.

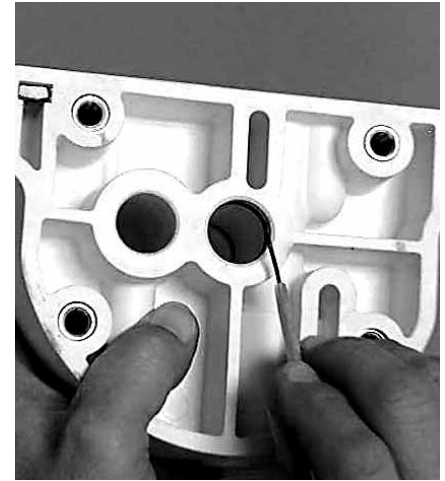

Step 8

Inspect center section seals for signs of wear. If necessary, remove seals with o-ring pick and replace.

PRO-FLO X™ AIR DISTRIBUTION SYSTEM (ADS) DISASSEMBLY

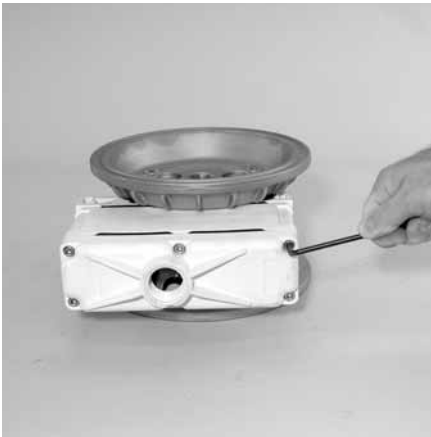

Step 1. *Figure 1*

Loosen the air valve bolts using a 3/16" hex wrench.



Step 2. *Figure 2*

Remove air valve bolts, muffler plate, and air valve assembly exposing muffer gasket and air valve gasket. Replace if necessary.



Step 3. *Figure 3*

Remove air valve end cap to expose the large end of air valve spool by simply lifting up on the air valve end cap once the bolts have been removed.



Step 4. *Figure 4*

Remove air valve spool from air valve body by threading one air valve bolt into the end of the spool and gently sliding the spool out of the air valve body. Inspect seals for signs of wear and replace entire assembly if necessary. Use caution when handling air valve spool to prevent damaging seals.

NOTE: Seals should not be removed from assembly. Seals are not sold separately.



Step 5. *Figure 5*

Remove pilot spool retaining snap ring on both sides of the center section using snap ring pliers.



Step 6-6A. *Figure 6*

Remove the air chamber bolts using a 1/4" hex wrench.

PRO-FLO X™ AIR DISTRIBUTION SYSTEM (ADS) DISASSEMBLY

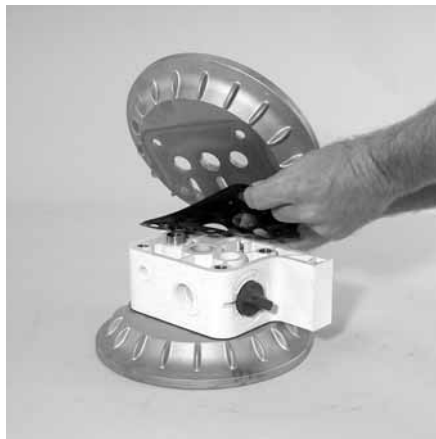

Step 7. *Figure 7*

Remove the air chamber and inspect air chamber gaskets (2). Replace if necessary.

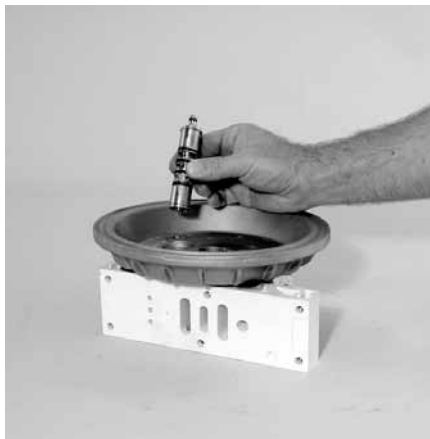

Step 8. *Figure 8*

Remove the pilot spool from the center section.



Step 9. *Figure 9*

With o-ring pick, gently remove the o-ring from the opposite side of the "center hole" cut on the spool. Gently remove the pilot spool from sleeve and inspect for nicks or gouges and other signs of wear. Replace pilot sleeve assembly or outer sleeve o-rings if necessary. During re-assembly never insert the pilot spool into the sleeve with the "center cut" side first, this end incorporates the urethane o-ring and will be damaged as it slides over the ports cut in the sleeve.

NOTE: Seals should not be removed from pilot spool. Seals are not sold separately.

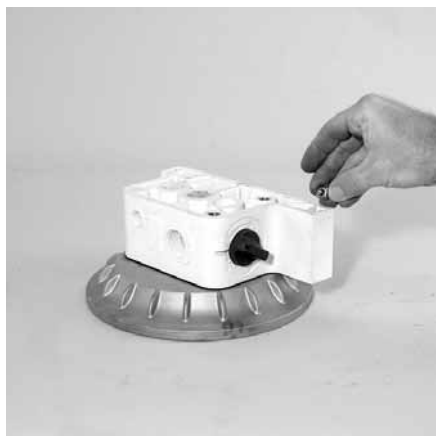

Step 10. *Figure 10*

Once the air chambers have been removed, the square air valve nuts (6) may be removed or replaced if necessary.

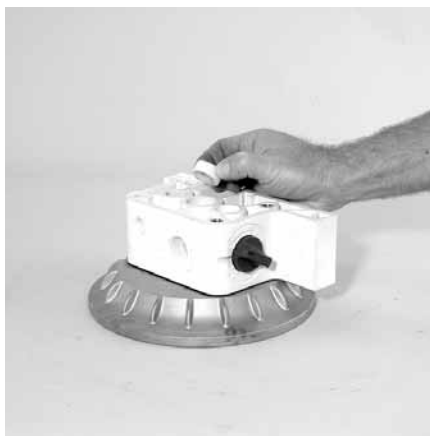

Step 11. *Figure 11*

Remove and inspect the shaft bushings (2) replace if necessary.



Step 12. *Figure 12*

Inspect center block Glyd rings (2) for wear. If replacement is necessary, use an o-ring pick to remove the used Glyd rings then replace with genuine Wilden replacement parts.

ASSEMBLY:

Upon performing applicable maintenance to the air distribution system, the pump can now be reassembled. Please refer to the disassembly instructions for photos and parts placement. To reassemble the pump, follow the disassembly instructions in reverse order. The air distribution system needs to be assembled first, then the diaphragms and finally the wetted path. Please find the applicable torque specifications on this page. The following tips will assist in the assembly process.

- Lubricate air valve bore, center section shaft and pilot spool bore with NLGI grade 2 white EP bearing grease or equivalent.
- Clean the inside of the center section shaft bore to ensure no damage is done to new seals.
- A small amount NLGI grade 2 white EP bearing grease can be applied to the muffler and air valve gaskets to locate gaskets during assembly.
- Make sure that the exhaust port on the muffler plate is centered between the two exhaust ports on the center section.
- Stainless bolts should be lubed to reduce the possibility of seizing during tightening.

PRO-FLO® MAXIMUM TORQUE SPECIFICATIONS

Description of Part	Torque
Pro-Flo® Air Valve Bolts	5.1 N•m (45 in-lbs)
Air Chamber to Center Block	27.1 N•m (20 ft-lbs)
Outer Piston	47.5 N•m (35 ft-lbs)
Manifolds to Liquid Chamber	9.6 N•m (85 in-lbs)
Liquid Chamber to Air Chamber	9.6 N•m (85 in-lbs)

PRO-FLO X™ MAXIMUM TORQUE SPECIFICATIONS

Description of Part	Torque
Pro-Flo® Air Valve Bolts	5.1 N•m (45 in-lbs)
Air Chamber to Center Block	27.1 N•m (20 ft-lbs)
Outer Piston	47.5 N•m (35 ft-lbs)
Manifolds to Liquid Chamber	9.6 N•m (85 in-lbs)
Liquid Chamber to Air Chamber	9.6 N•m (85 in-lbs)

SHAFT SEAL INSTALLATION:

PRE-INSTALLATION

- Once all of the old seals have been removed, the inside of the bushing should be cleaned to ensure no debris is left that may cause premature damage to the new seals.

INSTALLATION

The following tools can be used to aid in the installation of the new seals:

- Needle Nose Pliers
- Phillips Screwdriver
- Electrical Tape

- Wrap electrical tape around each leg of the needle nose pliers (heat shrink tubing may also be used). This is done to prevent damaging the inside surface of the new seal.
- With a new seal in hand, place the two legs of the needle nose pliers inside the seal ring. (See Figure A.)
- Open the pliers as wide as the seal diameter will allow, then with two fingers pull down on the top portion of the seal to form kidney bean shape. (See Figure B.)
- Lightly clamp the pliers together to hold the seal into the kidney shape. Be sure to pull the seal into as tight of a kidney shape as possible, this will allow the seal to travel down the bushing bore easier.
- With the seal clamped in the pliers, insert the seal into the bushing bore and position the bottom of the seal into the correct groove. Once the bottom of the seal is seated in the groove, release the clamp pressure on the pliers. This will allow the seal to partially snap back to its original shape.
- After the pliers are removed, you will notice a slight bump in the seal shape. Before the seal can be properly resized, the bump in the seal should be removed as much as possible. This can be done with either the Phillips screwdriver or your finger. With either the side of the screwdriver or your finger, apply light pressure to the peak of the bump. This pressure will cause the bump to be almost completely eliminated.
- Lubricate the edge of the shaft with NLGI grade 2 white EP bearing grease.
- Slowly insert the center shaft with a rotating motion. This will complete the resizing of the seal.
- Perform these steps for the remaining seal.

Figure A

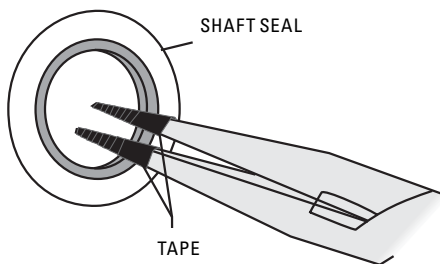
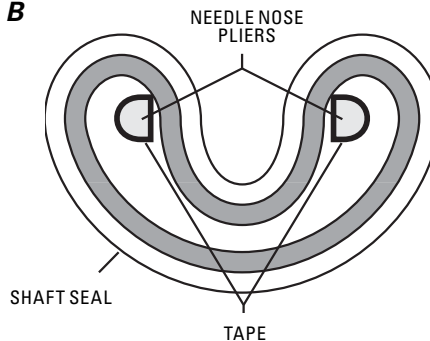

Figure B



NOTES

EXPLODED VIEW AND PARTS LISTING

P400 PLASTIC Full Stroke Fitted

EXPLODED VIEW

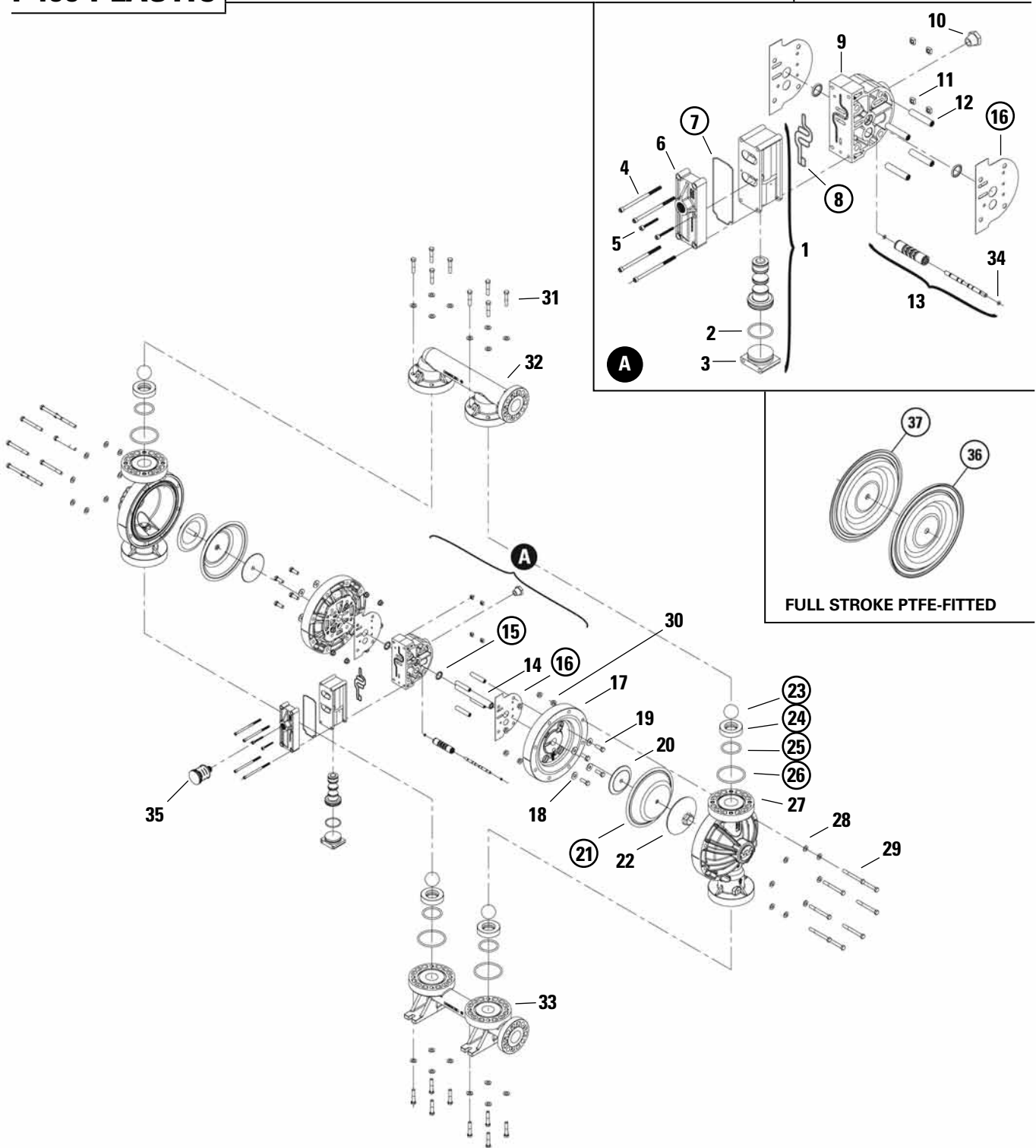

ALL CIRCLED PART IDENTIFIERS ARE INCLUDED IN REPAIR KITS (see section 9).

EXPLODED VIEW AND PARTS LISTING

P400 PLASTIC

Full Stroke Fitted

PARTS LISTING

Item	Part Description	Qty.	P400/PPPPP P/N	P400/PPPPP/0502 P/N	P400/KKPPP P/N	P400/KKPPP/0502 P/N
1	Pro-Flo® Air Valve Assembly¹	1	04-2000-20-700	04-2000-20-700	04-2000-20-700	04-2000-20-700
2	O-Ring (-225), End Cap (1.859" X .139")	1	04-2390-52-700	04-2390-52-700	04-2390-52-700	04-2390-52-700
3	End Cap, Pro-Flo®	1	04-2330-20-700	04-2330-20-700	04-2330-20-700	04-2330-20-700
4	Screw, HHC, Air Valve (1/4" x 4.5")	4	01-6000-03	01-6000-05	01-6000-03	01-6000-05
5	Screw, SHCS, 10-16 x 1 3/4"	2	04-6351-03	04-6351-03	04-6351-03	04-6351-03
6	Muffler Plate, Pro-Flo®	1	04-3180-20-700	04-3180-20-700	04-3180-20-700	04-3180-20-700
7	Gasket, Muffler Plate	1	04-3500-52-700	04-3500-52-700	04-3500-52-700	04-3500-52-700
8	Gasket, Air Valve	1	04-2600-52-700	04-2600-52-700	04-2600-52-700	04-2600-52-700
9	Center Block Assembly	1	04-3110-20	04-3110-20	04-3110-20	04-3110-20
10	Bushing, Reducer, NPT/BSP Combo	1	04-6950-20-700	04-6950-20-700	04-6950-20-700	04-6950-20-700
11	Nut, Hex, 1/4"-20	4	00-6505-03	00-6505-05	00-6505-03	00-6505-05
12	Sleeve, Threaded, Pro-Flo® Center Block	4	04-7710-08	04-7710-08	04-7710-08	04-7710-08
13	Removable Pilot Sleeve Assembly	1	04-3882-99	04-3882-99	04-3882-99	04-3882-99
14	Shaft, Pro-Flo®	1	04-3811-03	04-3811-03	04-3811-03	04-3811-03
15	Glyd™ Ring	2	08-3210-55-225	08-3210-55-225	08-3210-55-225	08-3210-55-225
16	Gasket, Center Block, Pro-Flo®	2	04-3526-52	04-3526-52	04-3526-52	04-3526-52
17	Air Chamber, Pro-Flo®	2	04-3681-20	04-3681-20	04-3681-20	04-3681-20
18	Washer, Flat, 3/8" x 13/32"	8	04-6741-03	04-6741-03	04-6741-03	04-6741-03
19	Screw, HHCS, 3/8"-16 x 1-1/4"	8	04-6190-03	04-6190-03	04-6190-03	04-6190-03
20	Inner Piston	2	04-3700-01-700	04-3700-01-700	04-3700-01-700	04-3700-01-700
21	Diaphragm	2	*	*	*	*
22	Outer Piston	2	04-4550-20-500	04-4550-20-500	04-4550-21-500	04-4550-21-500
23	Valve Ball	4	*	*	*	*
24	Valve Seat	4	04-1125-20	04-1125-20	04-1125-21	04-1125-21
25	Valve Seat O-Ring (2.250" x .210")	4	*	*	*	*
26	Manifold O-Ring (3.350" x .210")	4	*	*	*	*
27	Chamber, Liquid	2	04-5005-20	04-5005-20	04-5005-21	04-5005-21
28	Washer, Plain	32	04-6740-03	05-6740-05	04-6740-03	05-6740-05
29	Screw, HHCS, 3/8"-16 x 3.50"	16	04-6191-03	04-6191-05	04-6191-03	04-6191-05
30	Nut, Hex Flange, 3/8"-16	16	04-6435-03	04-6435-05	04-6435-03	04-6435-05
31	Screw, HHCS, 3/8"-16 x 1.75"	16	04-6181-03	04-6181-05	04-6181-03	04-6181-05
32	Manifold, Discharge	1	04-5030-20	04-5030-20	04-5030-21	04-5030-21
33	Manifold, Inlet	1	04-5090-20	04-5090-20	04-5090-21	04-5090-21
34	Pilot Spool Retaining O-Ring	2	04-2650-49-700	04-2650-49-700	04-2650-49-700	04-2650-49-700
35	Muffler	1	04-3510-99	04-3510-99	04-3510-99	04-3510-99
36	Diaphragm Full Stroke PTFE, Primary	2	04-1040-55	04-1040-55	04-1040-55	04-1040-55
37	Diaphragm Full Stroke PTFE, Back-Up	2	04-1065-57	04-1065-57	04-1065-57	04-1065-57

¹Air Valve Assembly includes item numbers 2 and 3

BSP to NPT Air Line Reducer Bushing (P/N 04-6950-23-702) is available upon request.

0502 Specialty Code = PFA-Coated Hardware

0504 Specialty Code = DIN Flange

* Refer to elastomer chart.

All boldface items are primary wear parts.

EXPLODED VIEW AND PARTS LISTING

P400 PLASTIC

Reduced Stroke-Fitted

EXPLODED VIEW

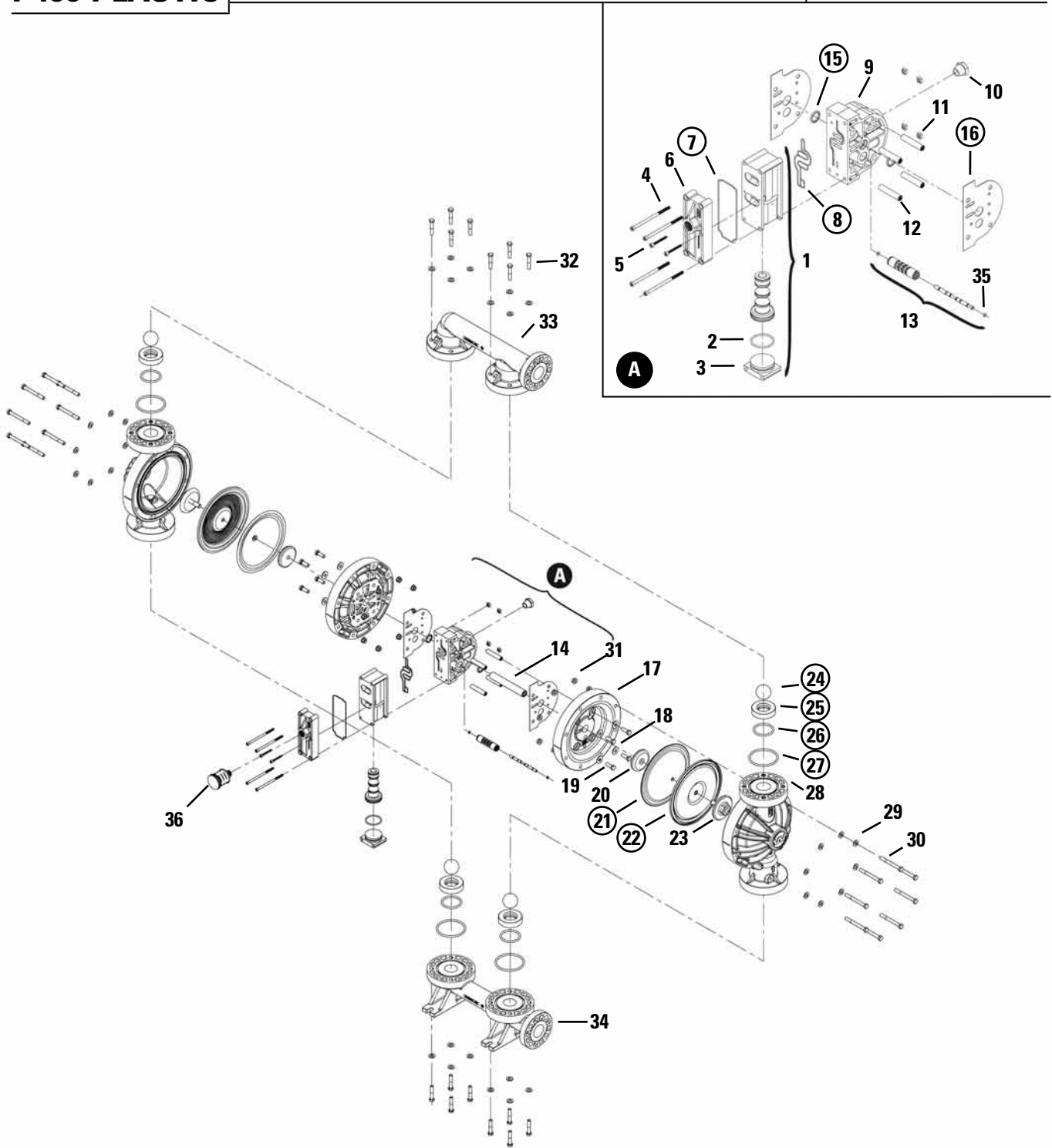

ALL CIRCLED PART IDENTIFIERS ARE INCLUDED IN REPAIR KITS (see section 9).

EXPLODED VIEW AND PARTS LISTING

P400 PLASTIC Reduced Stroke-Fitted

PARTS LISTING

Item	Part Description	Qty.	P400/PPPPP P/N	P400/PPPPP/0502 P/N	P400/KKPPP P/N	P400/KKPPP/0502 P/N
1	Pro-Flo® Air Valve Assembly¹	1	04-2000-20-700	04-2000-20-700	04-2000-20-700	04-2000-20-700
2	O-Ring (-225), End Cap (1.859" X .139")	1	04-2390-52-700	04-2390-52-700	04-2390-52-700	04-2390-52-700
3	End Cap, Pro-Flo®	1	04-2330-20-700	04-2330-20-700	04-2330-20-700	04-2330-20-700
4	Screw, HHC, Air Valve (1/4" x 4.5")	4	01-6000-03	01-6000-05	01-6000-03	01-6000-05
5	Screw, SHCS, 10-16 x 1-3/4"	2	04-6351-03	04-6351-03	04-6351-03	04-6351-03
6	Muffler Plate, Pro-Flo®	1	04-3180-20-700	04-3180-20-700	04-3180-20-700	04-3180-20-700
7	Gasket, Muffler Plate	1	04-3500-52-700	04-3500-52-700	04-3500-52-700	04-3500-52-700
8	Gasket, Air Valve	1	04-2600-52-700	04-2600-52-700	04-2600-52-700	04-2600-52-700
9	Center Block Assembly	1	04-3110-20	04-3110-20	04-3110-20	04-3110-20
10	Bushing, Reducer, NPT/BSP Combo	1	04-6950-20-700	04-6950-20-700	04-6950-20-700	04-6950-20-700
11	Nut, Hex, 1/4"-20	4	00-6505-03	00-6505-03	00-6505-03	00-6505-03
12	Sleeve, Threaded, Pro-Flo® Center Block	4	04-7710-08	04-7710-08	04-7710-08	04-7710-08
13	Removable Pilot Sleeve Assembly	1	04-3882-99	04-3882-99	04-3882-99	04-3882-99
14	Shaft, Pro-Flo®	1	04-3842-03	04-3842-03	04-3842-03	04-3842-03
15	Glyd™ Ring	2	08-3210-55-225	08-3210-55-225	08-3210-55-225	08-3210-55-225
16	Gasket, Center Block, Pro-Flo®	2	04-3526-52	04-3526-52	04-3526-52	04-3526-52
17	Air Chamber, Pro-Flo®	2	04-3681-20	04-3681-20	04-3681-20	04-3681-20
18	Washer, Flat 3/8" x 13/32"	8	04-6741-03	04-6741-03	04-6741-03	04-6741-03
19	Screw, HHCS, 3/8"-16 x 1-1/4"	8	04-6190-03	04-6190-03	04-6190-03	04-6190-03
20	Inner Piston	2	04-3752-01	04-3752-01	04-3752-01	04-3752-01
21	Diaphragm, Back-up	2	04-1060-51	04-1060-51	04-1060-51	04-1060-51
22	Diaphragm, PTFE	2	04-1010-55	04-1010-55	04-1010-55	04-1010-55
23	Outer Piston	2	04-4600-20-500	04-4600-20-500	04-4600-21-500	04-4600-21-500
24	Valve Ball	4	04-1080-55	04-1080-55	04-1080-55	04-1080-55
25	Valve Seat	4	04-1125-20	04-1125-20	04-1125-21	04-1125-21
26	Valve Seat O-Ring (2.250" x .210")	4	08-1300-60-500	08-1300-60-500	08-1300-60-500	08-1300-60-500
27	Manifold O-Ring (3.350" x .210")	4	04-1371-60	04-1371-60	04-1371-60	04-1371-60
28	Chamber, Liquid	2	04-5005-20	04-5005-20	04-5005-21	04-5005-21
29	Washer, Flat	32	04-6740-03	05-6740-05	04-6740-03	05-6740-05
30	Screw, HHCS, 3/8"-16 x 3.50"	16	04-6191-03	04-6191-05	04-6191-03	04-6191-05
31	Nut, Hex Flange, 3/8"-16	16	04-6435-03	04-6435-05	04-6435-03	04-6435-05
32	Screw, HHCS, 3/8"-16 x 1.75"	16	04-6181-03	04-6181-05	04-6181-03	04-6181-05
33	Manifold, Discharge	1	04-5030-20	04-5030-20	04-5030-21	04-5030-21
34	Manifold, Inlet	1	04-5090-20	04-5090-20	04-5090-21	04-5090-21
35	Pilot Spool Retaining O-Ring	2	04-2650-49-700	04-2650-49-700	04-2650-49-700	04-2650-49-700
36	Muffler	1	04-3510-99	04-3510-99	04-3510-99	04-3510-99

¹Air Valve Assembly includes item numbers 2 and 3
 BSP to NPT Air Line Reducer Bushing (P/N 04-6950-23-702) is available upon request.
 0502 Specialty Code = PFA-Coated Hardware
 0504 Specialty Code = DIN Flange
All boldface items are primary wear parts.

EXPLODED VIEW AND PART LISTINGS

PX400 PLASTIC Full Stroke-Fitted

EXPLODED VIEW

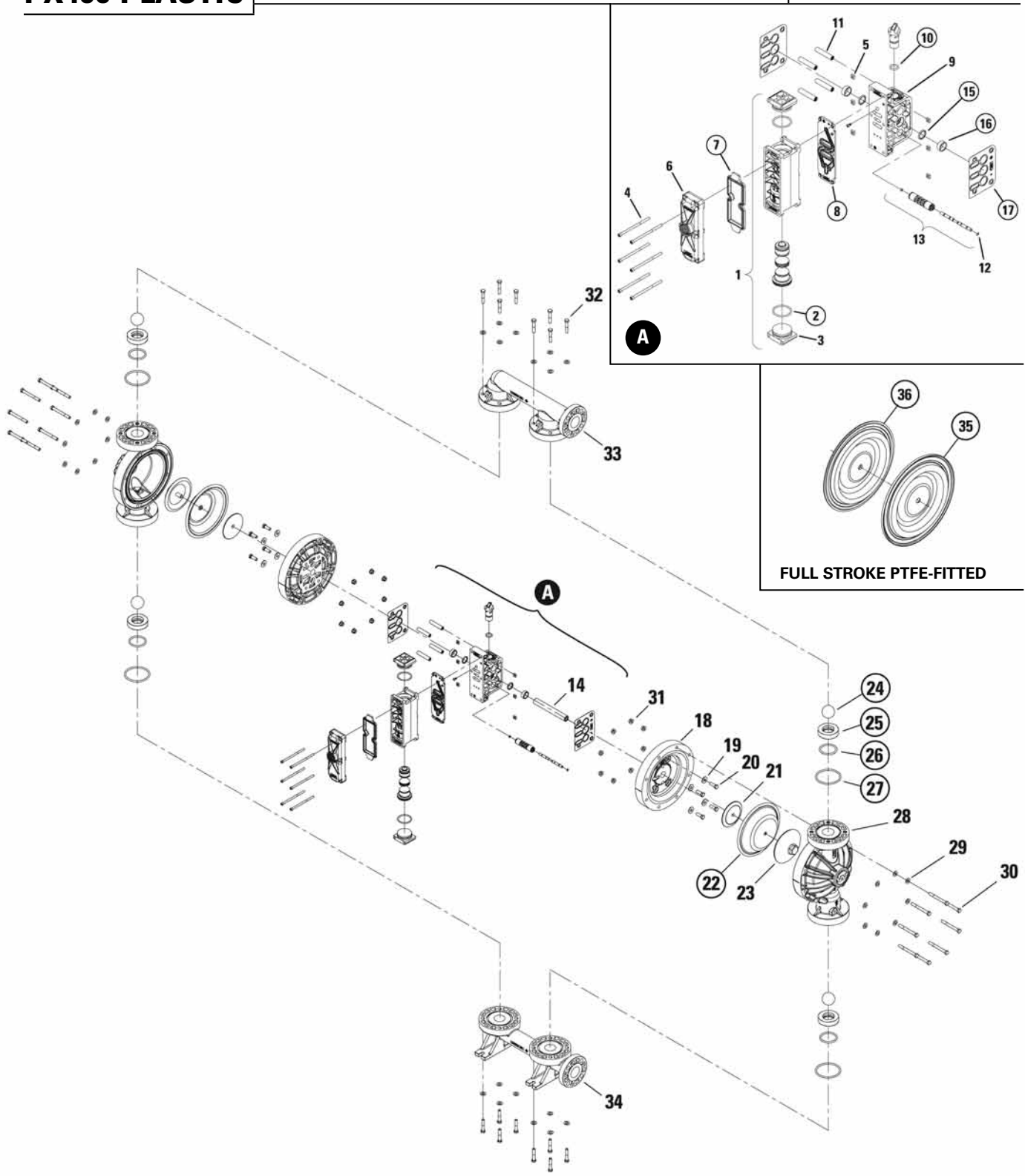

ALL CIRCLED PART IDENTIFIERS ARE INCLUDED IN REPAIR KITS (see section 9).



EXPLODED VIEW AND PART LISTINGS

PX400 PLASTIC Full Stroke-Fitted

PARTS LISTING

Item	Description	Qty.	PX400/PPPPP P/N	PX400/KKPPP P/N	PX400/PPPPP/ 0502 P/N	PX400/KKPPP/ 0502 P/N
1	Pro-Flo X™ Assembly, Air Valve ¹	1	08-2030-20	08-2030-20	08-2030-20	08-2030-20
2	O-Ring (-225), End Cap (Ø1.859" x Ø.139")	2	04-2390-52-700	04-2390-52-700	04-2390-52-700	04-2390-52-700
3	End Cap	2	04-2330-20-700	04-2330-20-700	04-2330-20-700	04-2330-20-700
4	Screw, SHC, Air Valve (1/4"-20 x 4-1/2")	6	01-6000-03	01-6000-03	01-6000-05	01-6000-05
5	Nut, Square (1/4"-20)	6	00-6505-03	00-6505-03	00-6505-05	00-6505-05
6	Muffler Plate, Pro-Flo X™	1	08-3185-20	08-3185-20	08-3185-20	08-3185-20
7	Gasket, Muffler Plate, Pro-Flo X™	1	08-3502-52	08-3502-52	08-3502-52	08-3502-52
8	Gasket, Air Valve, Pro-Flo X™	1	08-2620-52	08-2620-52	08-2620-52	08-2620-52
9	Center Block Assembly, Pro-Flo X™ ²	1	08-3126-20	08-3126-20	08-3126-20	08-3126-20
10	O-Ring (-210), Adjuster (Ø.734" x Ø.139")	1	02-3200-52	02-3200-52	02-3200-52	02-3200-52
11	Sleeve, Threaded, Center Block	4	04-7710-08	04-7710-08	04-7710-08	04-7710-08
12	Pilot Spool Retaining O-Ring (Ø.204" x Ø.070")	2	04-2650-49-700	04-2650-49-700	04-2650-49-700	04-2650-49-700
13	Removable Pilot Sleeve Assembly	1	04-3882-99	04-3882-99	04-3882-99	04-3882-99
14	Shaft, Pro-Flo® Rubber Advanced	1	04-3811-03	04-3811-03	04-3811-03	04-3811-03
15	Shaft Seal	2	08-3210-55-225	08-3210-55-225	08-3210-55-225	08-3210-55-225
16	Shaft Bushing	2	08-3306-13	08-3306-13	08-3306-13	08-3306-13
17	Gasket, Center Block Pro-Flo V™	2	04-3529-52	04-3529-52	04-3529-52	04-3529-52
18	Air Chamber, Pro-Flo V™	2	04-3690-20	04-3690-20	04-3690-20	04-3690-20
19	Washer, Flat (13/32" x 7/8")	8	04-6741-03	04-6741-03	04-6741-03	04-6741-03
20	Screw, HHC (3/8"-16 x 1 1/4")	8	04-6190-03	04-6190-03	04-6190-03	04-6190-03
21	Inner Piston	2	04-3700-01-700	04-3700-01-700	04-3700-01-700	04-3700-01-700
22	Diaphragm	2	*	*	*	*
23	Outer Piston	2	04-4550-20-500	04-4550-21-500	04-4550-20-500	04-4550-21-500
24	Valve Ball	4	*	*	*	*
25	Valve Seat	4	04-1125-20	04-1125-21	04-1125-20	04-1125-21
26	Valve Seat O-Ring (Ø2.250" x Ø.210")	4	*	*	*	*
27	Manifold O-Ring (Ø3.350" x Ø.210")	4	*	*	*	*
28	Chamber, Liquid	2	04-5005-20	04-5005-21	04-5005-20	04-5005-21
29	Washer, Plain (13/32" x 13/16")	32	04-6740-03	04-6740-03	04-6740-05	04-6740-05
30	Screw, HHCS (3/8"-16 x 3.50")	16	04-6191-03	04-6191-03	04-6191-05	04-6191-05
31	Nut, Hex Flange (3/8"-16)	16	04-6435-03	04-6435-03	04-6435-05	04-6435-05
32	Screw, HHCS, (3/8"-16 x 1.75")	16	04-6181-03	04-6181-03	04-6181-05	04-6181-05
33	Manifold, Discharge	1	04-5030-20	04-5030-21	04-5030-20	04-5030-21
34	Manifold, Inlet	1	04-5090-20	04-5090-21	04-5090-20	04-5090-21
35	Diaphragm Full Stroke PTFE, Primary	2	04-1040-55	04-1040-55	04-1040-55	04-1040-55
36	Diaphragm Full Stroke PTFE, Back-Up	2	04-1065-57	04-1065-57	04-1065-57	04-1065-57
	Muffler 1" (not Shown)	1	15-3514-99	15-3514-99	15-3514-99	15-3514-99

¹ Air Valve Assembly includes items 2 and 3.

² Center Block Assembly includes items 10, 11, 15 and 16.

BSPT to NPT Air Line Reducer Bushing (P/N 04-6950-23-702) is available upon request

0502 Specialty Code = PFA Coated Hardware

0504 Specialty Code = DIN Flange

*Refer to Elastomer Chart.

All boldface items are primary wear parts.

EXPLODED VIEW AND PART LISTINGS

PX400 PLASTIC Reduced Stroke-Fitted

EXPLODED VIEW

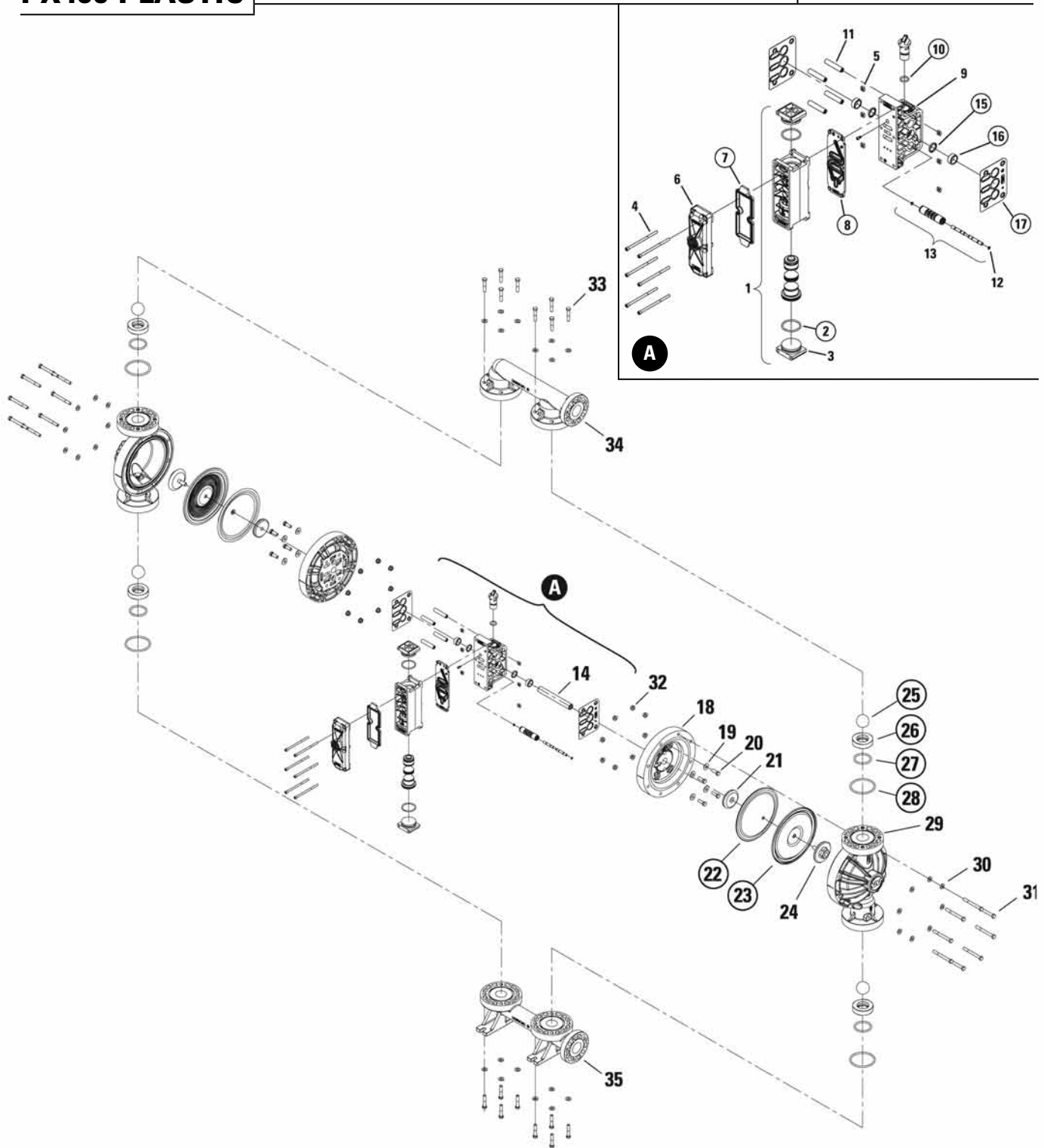

ALL CIRCLED PART IDENTIFIERS ARE INCLUDED IN REPAIR KITS (see section 9).



EXPLODED VIEW AND PART LISTINGS

PX400 PLASTIC

Reduced Stroke-Fitted

PARTS LISTING

Item	Description	Qty.	PX400/PPPPP P/N	PX400/KKPPP P/N	PX400/PPPPP/ 0502 P/N	PX400/KKPPP/ 0502 P/N
1	Pro-Flo X™ Assembly, Air Valve ¹	1	08-2030-20	08-2030-20	08-2030-20	08-2030-20
2	O-Ring (-225), End Cap (Ø1.859" x Ø.139")	2	04-2390-52-700	04-2390-52-700	04-2390-52-700	04-2390-52-700
3	End Cap	2	04-2330-20-700	04-2330-20-700	04-2330-20-700	04-2330-20-700
4	Screw, SHC, Air Valve (1/4"-20 x 4-1/2")	6	01-6000-03	01-6000-03	01-6000-05	01-6000-05
5	Nut, Square (1/4"-20)	6	00-6505-03	00-6505-03	00-6505-05	00-6505-05
6	Muffler Plate, Pro-Flo X™	1	08-3185-20	08-3185-20	08-3185-20	08-3185-20
7	Gasket, Muffler Plate, Pro-Flo X™	1	08-3502-52	08-3502-52	08-3502-52	08-3502-52
8	Gasket, Air Valve, Pro-Flo X™	1	08-2620-52	08-2620-52	08-2620-52	08-2620-52
9	Center Block Assembly, Pro-Flo X™ ²	1	08-3126-20	08-3126-20	08-3126-20	08-3126-20
10	O-Ring (-210), Adjuster (Ø.734" x Ø.139")	1	02-3200-52	02-3200-52	02-3200-52	02-3200-52
11	Sleeve, Threaded, Center Block	4	04-7710-08	04-7710-08	04-7710-08	04-7710-08
12	Pilot Spool Retaining O-Ring (Ø.204" x Ø.070")	2	04-2650-49-700	04-2650-49-700	04-2650-49-700	04-2650-49-700
13	Removable Pilot Sleeve Assembly	1	04-3882-99	04-3882-99	04-3882-99	04-3882-99
14	Shaft, Pro-Flo® PTFE Advanced	1	04-3842-03	04-3842-03	04-3842-03	04-3842-03
15	Shaft Seal	2	08-3210-55-225	08-3210-55-225	08-3210-55-225	08-3210-55-225
16	Shaft Bushing	2	08-3306-13	08-3306-13	08-3306-13	08-3306-13
17	Gasket, Center Block Pro-Flo V™	2	04-3529-52	04-3529-52	04-3529-52	04-3529-52
18	Air Chamber, Pro-Flo V™	2	04-3690-20	04-3690-20	04-3690-20	04-3690-20
19	Washer, Flat, (13/32" x 7/8")	8	04-6741-03	04-6741-03	04-6741-03	04-6741-03
20	Screw, HHC (3/8"-16 x 1 1/4")	8	04-6190-03	04-6190-03	04-6190-03	04-6190-03
21	Inner Piston	2	04-3752-01	04-3752-01	04-3752-01	04-3752-01
22	Diaphragm, Back-up	2	04-1060-51	04-1060-51	04-1060-51	04-1060-51
23	Diaphragm, PTFE	2	04-1010-55	04-1010-55	04-1010-55	04-1010-55
24	Outer Piston	2	04-4600-20-500	04-4600-21-500	04-4600-20-500	04-4600-21-500
25	Valve Ball	4	04-1080-55	04-1080-55	04-1080-55	04-1080-55
26	Valve Seat	4	04-1125-20	04-1125-21	04-1125-20	04-1125-21
27	Valve Seat O-Ring (Ø2.250" x Ø.210")	4	08-1300-60-500	08-1300-60-500	08-1300-60-500	08-1300-60-500
28	Manifold O-Ring (Ø3.350" x Ø.210")	4	04-1371-60	04-1371-60	04-1371-60	04-1371-60
29	Chamber, Liquid	2	04-5005-20	04-5005-21	04-5005-20	04-5005-21
30	Washer, Plain (13/32" x 13/16")	32	04-6740-03	04-6740-03	04-6740-05	04-6740-05
31	Screw, HHCS (3/8"-16 x 3.50")	16	04-6191-03	04-6191-03	04-6191-05	04-6191-05
32	Nut, Hex Flange (3/8"-16)	16	04-6435-03	04-6435-03	04-6435-05	04-6435-05
33	Screw, HHCS (3/8"-16 x 1.75")	16	04-6181-03	04-6181-03	04-6181-05	04-6181-05
34	Manifold, Discharge	1	04-5030-20	04-5030-21	04-5030-20	04-5030-21
35	Manifold, Inlet	1	04-5090-20	04-5090-21	04-5090-20	04-5090-21
	Muffler 1" (not Shown)	1	15-3514-99	15-3514-99	15-3514-99	15-3514-99

¹ Air Valve Assembly includes items 2 and 3.

² Center Block Assembly includes items 10, 11, 15 and 16.

BSPT to NPT Air Line Reducer Bushing (P/N 04-6950-23-702) is available upon request

0502 Specialty Code = PFA Coated Hardware

0504 Specialty Code = DIN Flange

*Refer to Elastomer Chart.

All boldface items are primary wear parts.

ELASTOMER OPTIONS

P400 and PX400 Plastic

MATERIAL	DIAPHRAGMS (2)	BACK-UP DIAPHRAGMS	VALVE BALLS (4)	VALVE SEAT (4)	VALVE SEAT O-RING (4)	FLANGE O-RING
Neoprene	04-1010-51	04-1060-511	04-1080-51	N/A	N/A	N/A
Buna-N	04-1010-52	N/A	04-1080-52	N/A	08-1300-52-500	04-1371-52
Viton®	04-1010-53	N/A	04-1080-53	N/A	N/A	N/A
EPDM	04-1010-54	N/A	04-1080-54	N/A	N/A	N/A
PTFE	04-1010-55	N/A	04-1080-55	N/A	N/A	N/A
Full Stroke PTFE	04-1040-55					
PTFE Encap. (Viton®)	N/A	N/A	N/A	N/A	08-1300-60-500	04-1371-60
Polyurethane	04-1010-50	N/A	04-1080-50	N/A	N/A	N/A
Saniflex™	04-1010-56	04-1060-56	04-1080-56	N/A	N/A	N/A
Wil-Flex™	04-1010-58	01-1065-57	04-1080-58	N/A	04-1205-58	04-1371-58
Polypropylene	N/A	N/A	N/A	04-1125-20	N/A	N/A
PVDF	N/A	N/A	N/A	04-1125-21	N/A	N/A

Back-up diaphragms used with PTFE diaphragms only. Neoprene is the standard back-up material used, unless otherwise specified.

NOTE: Saniflex™ back-up diaphragms (04-1060-56) are available upon request. Please consult your local Wilden distributor.

ELASTOMER KIT OPTIONS

PRO-FLO®

DESCRIPTION	NEOPRENE	BUNA-N	VITON®	EPDM
Pro-Flo® Advanced™ Plastic	04-9553-51	04-9553-52	04-9553-53	04-9553-54
DESCRIPTION	PTFE	WIL-FLEX™	SANIFLEX™	POLYURETHANE
Pro-Flo® Advanced™ Plastic	04-9553-55	04-9553-58	04-9553-56	04-9553-50

PRO-FLO X™

DESCRIPTION	NEOPRENE	BUNA-N	VITON®	EPDM
Pro-Flo X™ Advanced™ Plastic	04-9581-51	04-9581-52	04-9581-53	04-9581-54
DESCRIPTION	PTFE	WIL-FLEX™	SANIFLEX™	POLYURETHANE
Pro-Flo X™ Advanced™ Plastic	04-9581-55	04-9581-58	04-9581-56	04-9581-50

WARRANTY

Each and every product manufactured by Wilden Pump and Engineering, LLC is built to meet the highest standards of quality. Every pump is functionally tested to insure integrity of operation.

Wilden Pump and Engineering, LLC warrants that pumps, accessories and parts manufactured or supplied by it to be free from defects in material and workmanship for a period of five (5) years from date of installation or six (6) years from date of manufacture, whichever comes first. Failure due to normal wear, misapplication, or abuse is, of course, excluded from this warranty.

Since the use of Wilden pumps and parts is beyond our control, we cannot guarantee the suitability of any pump or part for a particular application and Wilden Pump and Engineering, LLC shall not be liable for any consequential damage or expense arising from the use or misuse of its products on any application. Responsibility is limited solely to replacement or repair of defective Wilden pumps and parts.

All decisions as to the cause of failure are the sole determination of Wilden Pump and Engineering, LLC.

Prior approval must be obtained from Wilden for return of any items for warranty consideration and must be accompanied by the appropriate MSDS for the product(s) involved. A Return Goods Tag, obtained from an authorized Wilden distributor, must be included with the items which must be shipped freight prepaid.

The foregoing warranty is exclusive and in lieu of all other warranties expressed or implied (whether written or oral) including all implied warranties of merchantability and fitness for any particular purpose. No distributor or other person is authorized to assume any liability or obligation for Wilden Pump and Engineering, LLC other than expressly provided herein.

PLEASE PRINT OR TYPE AND FAX TO WILDEN

PUMP INFORMATION			
Item # _____		Serial # _____	
Company Where Purchased _____			
YOUR INFORMATION			
Company Name _____			
Industry _____			
Name _____		Title _____	
Street Address _____			
City _____		State _____	Postal Code _____
Country _____			
Telephone _____		Fax _____	Web Address _____
E-mail _____			
Number of pumps in facility? _____		Number of Wilden pumps? _____	
Types of pumps in facility (check all that apply): <input type="checkbox"/> Diaphragm <input type="checkbox"/> Centrifugal <input type="checkbox"/> Gear <input type="checkbox"/> Submersible <input type="checkbox"/> Lobe			
<input type="checkbox"/> Other _____			
Media being pumped? _____			
How did you hear of Wilden Pump? <input type="checkbox"/> Trade Journal <input type="checkbox"/> Trade Show <input type="checkbox"/> Internet/E-mail <input type="checkbox"/> Distributor			
<input type="checkbox"/> Other _____			

ONCE COMPLETE, FAX TO (909) 783-3440

NOTE: WARRANTY VOID IF PAGE IS NOT FAXED TO WILDEN
WILDEN PUMP & ENGINEERING, LLC